



MOLAS DE FIXAÇÃO



We Sparkle your business

AUTO BODY CLIPS

AUDI - VW SEAT - SKODA	1
BMW	17
CITROEN - PEUGEOT RENAULT	25
FIAT - LANCIA ALFA ROMEO IVECO	33
FORD - VOLVO	37
OPEL - DAEWOO SAAB GM - CHEVROLET - PONTIAN CHRYSLER - JEEP	45
MERCEDES BENZ	55
SUBARU - SUZUKI HYUNDAI - ISUZU - KIA	61
TOYOTA - MAZDA NISSAN LEXUS - MITSUBISHI HONDA - ROVER	67
UNIVERSAL	85
HOSE MENDERS	112



CODE	OEM	MODEL	USAGE	Ø (mm)	T (mm)	H (mm)
01	VW 1H0853585	VW Golf 3 (1991-1997), Vento	Side Moulding Clips			
02	VW 1H0853585B	VW Golf 3, Vento	Side Moulding Clips			
05	VW191853585A	VW Golf 2, (1987-1990), Jetta, Vento, Passat 3 (1991-1997)	Side Moulding Clips			
20A,B	MERCEDES A0009902992, BMW 1916670, VW 16186729901C, N0385491, AUDI 16186729901C, N0385491, FORD 1104880, E844052S	WV Passat, Polo, Vento: Audi A3, A4, A6, Ford Escort Golf Bora, Golf, New Beetle, Passat, Polo, Vento, Phaeton, Transporter	Wheel Arch Cover Panel Clips Bumper Clips	8	16	14
25		Fits many models	Signal holder			
26	VW 1H0807193	Passat (1988-1998), Vento (1991-1998)	Bumper Clips			
27A,B,C	BMW 51471911992, MERCEDES BENZ A2019900292, VOLVO 30820141, AUDI VW 447857909	BMW 3'E30, 3'E36, 3'E46, 5'E34, 5'E39, 7'E38, 7'E65, X5, Z3, Z8. Mercedes. Fits many models Audi A3 (2013>), A8 (2003-2010) Volvo S40 (2000-2004), S60 (2001-2009), V40 (2000-2004), V70	Trim Panel Clips Trunk Bumper Clips	8	20	18
30A	AUDI, VW 4A0805121A	VW Passat (1997-2000). Audi 100, 80, A3, A4, A5, A6, A8, ALLROAD, TT	Plastic Twist Bolt Clip Pin- Engine Undertray Splashshield Arch Lining	6,2	25	28,3
30B	AUDI 4A0805121C	VW Passat (1997-2005), Audi A80, A100, A3, A4, A6, A8, Kupé Coupe, TT (1991-2007)	Plastic Twist Bolt Clip Pin- Engine Undertray Splashshield Arch Lining	6	25	28,7
30C	AUDI, WV 4A0805163	Audi A4, A6, A8, Rs5	Grommet Clip Nut for Engine Undertrays Splashguards Shields Flaps			
35A	AUDI 4A0853825	Audi A3, A4, A6, A8	Door Protection, Bumpstrip, Rubstrip Trim Clips	9,5	22 - 35	16,5
35B	AUDI 4A0853825A	Audi	Door Protection, Bumpstrip, Rubstrip Trim Clips	3	22 - 35	4,5
39	8EO698470B	VW, Audi, Seat, Ford	Brake Caliper Guide Sleeve			
48AB	48 OEM: 357853585A 48 A) OEM: 191853586D 48 B) OEM: 701853585	VW Golf, Passat (1988-1993)	Side Moulding Clips	9		

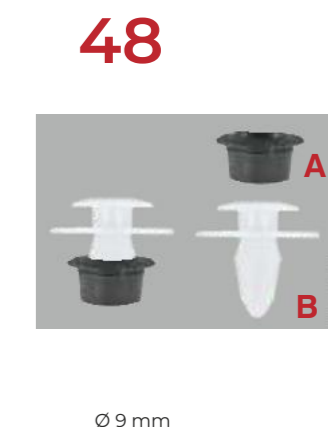
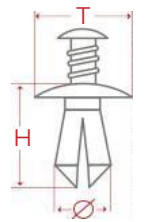

CODE	OEM	MODEL	USAGE	Ø (mm)	T (mm)	H (mm)
52	VW 3A0853586	VW Polo (1995 - 2000), Bora, Golf, Jetta, Passat, Touareg, Vento. Audi A3, TT	Side Moulding Clips	9	13	13,5
56		Audi A4, S4 ,B5, 8D, (1994 - 1999)	Protection rubber of Door opening / closing sensor			
61A,B	VW 7M0867299K	VW Sharan, Transporter, Polo Classic Audi A3, A6, A8	Door Trim Panel Retainers (extremely flexible). Anti-Vibration Rubber Washer.	8	13 - 18	21
70A,C	AUDI, VW 823867299	VW Golf, Corrado, Caddy, Passat, Polo, Transporter, Audi 100, 200, 80, A6, A8. Ford, BMW. Fits many models	Door Panel Trim. Anti-Vibration Rubber Washer	8	13 - 17	19
70B,D	VW, FORD 703867299	VW Sharan, Transporter. FORD Fits many models	Door Panel Trim. Anti-Vibration Rubber Washer	8	13 - 17	19
90		VW Passat (1999-190), Polo. Audi A4	Window Regulator Repair (Left Front)			
91		VW Golf 4, Bora, Skoda Fabia, Seat Ibiza (2002), Peugeot 607	Window Regulator Repair			
92		VW Passat (1999-1901), Polo, Audi A4	Window Regulator Repair (Right Front)			
107A,B	A) AUDI, VW 3C0853585 B) 3C0853586	Audi: RS5 2010, VW: Beetle 2012, Passat (2006 - 2011), Scirocco, Sharan (2011), Tiguan, Touareg (2011). Seat: Alhambra (2011). Skoda: Jety (2010)	Side Moulding Clips	A) 8,5 B) 7	13 - 18 16	21 16,5
108A,C		Fits many models	Trim Panel Clips. Anti-Vibration Rubber Washer	8	14,5 - 18	20
108B,D		Fits many models	Trim Panel Clips. Anti-Vibration Rubber Washer	8	14,5 - 18	20
116A	VW 867809966	VW Golf	Lock nut	6,5 - 7	9,5 - 9,5	12
116B	VW 165827592	VW Polo, Lupo, Passat, Vento, Transporter A8	Lock nut	6,5 - 7	12	12

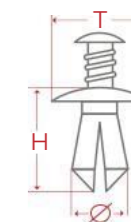

52



Ø 9 mm,
T = 13 mm,
H = 13,5 mm

56



61A



Ø 8 mm,
T = 13 - 18 mm,
H = 21 mm

70A



Ø 8 mm,
T = 13 - 17 mm,
H = 19 mm

70B



Ø 8 mm,
T = 13 - 17 mm,
H = 19 mm

90



91

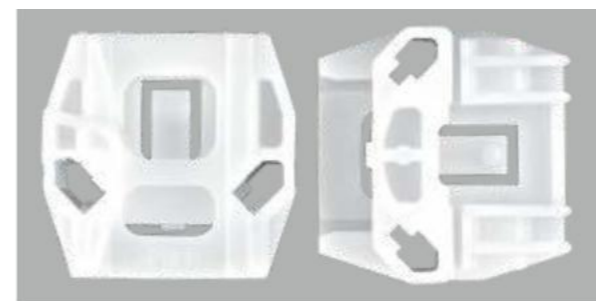

92



107A



A) Ø 8,5 mm, T = 13 - 18 mm, H = 21 mm
B) Ø 7 mm, T = 16 mm, H = 16,5 mm

108A



Ø 8 mm,
T = 14,5 - 18 mm,
H = 20 mm

108B



Ø 8 mm,
T = 14,5 - 18 mm,
H = 20 mm

116A



Ø 6,5 - 7 mm,
T = 9,5 - 9,5 mm,
H = 12 mm

116B



Ø 6,5 - 7 mm,
T = 12 mm,
H = 12 mm

CODE	OEM	MODEL	USAGE	Ø (mm)	T (mm)	H (mm)
117	VW 3A0853575	VW Passat B4	Side Moulding Clips	8	20	18
119A,B,C		Fits many models	Trim Panel Clips	8	25	6
120		Audi A3, A6	Regulator Repair			
124	VW 3B0853575A	VW Passat B5	Side Moulding Clips	8	12,7 - 17,3	13,7
130A,B,C	VW N90229301, RENAULT 7703072502, AUDI N90229301	VW, Audi 100, 200, 80, A6 Fits many models	Trim, Trunk Panel Clips	8	22	16,5
132A,B,C	VW, AUDI 3338676334FB	VW Passat, Bora, Polo, Vento: Audi A4	Trim, Trunk Panel Clips	8	14	12
136	AUDI, VW 3B0867333	VW Amarok (2010>), Bora 1999-2005, Caddy (2004>), Campmob (2004>), Golf (1998-2014>), Jetta (2006-2014), Lupo (1999-2006), Passat (1997>), Phaeton (2002>), Polo (2002>), Sharan (2001-2010), Tiguan (2008-2011), Touran (2003>), Touareg (2003-2010), Audi A1 (2011>), A3 (1997-2003), A8 (2004)	Trim Clips	5	12,3 - 16,5	21,5
141B	VW, AUDI 171201969	VW Scirocco, Passat, Vento, Golf, Lupo, Polo (1995-2000), Caddy, Phaeton: Audi A2, A4, A6, A8, 80, 100, 200	Trim, Trunk, Bumper Bumper, Engine, Trunk, Trim	4,5	18	11
141C	VW N90474001, AUDI 8E0825265C	VW Golf Audi A4, A8	Trim Covering under body	4,5	21	11,3
142	VW 1H0837719	VW Golf 3, Sharan, Vento, Transporter	Weatherstrip Clips - For rubber door seals, door gasket clips	5	6 - 15	18,5
143	WV 3B9863689	WV Passat B5	Trim Panel Clips	8	13	20,6
144A	AUDI, VW 8D0805121	Audi, VW. Fits many models	Engine Undertray Cover Fixing Clips. Suitable for this holder: 144C	4,2	18,3	21,5
144B	AUDI, VW 8D0805121B	Audi, VW	Fits many models: Engine Undertray Cover Fixing Clips. Suitable for this holder: 144C	4,2	18,3	22,5
144C	AUDI, VW 8D0805960	Audi, VW	Engine Protection Pan Speed Nut. Suitable for this holder: 144A, 144B	4,5	22 - 25	9

117

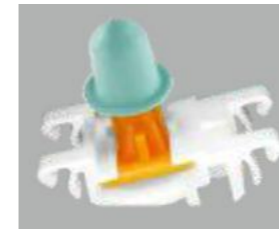

Ø 8 mm, T = 20 mm, H = 18 mm

119A **B** **C**



Ø 8 mm, T = 25 mm, H = 6 mm

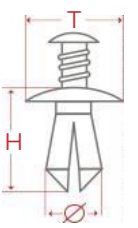

120



124



Ø 8 mm, T = 12,7 - 17,3 mm, H = 13,7 mm

130A **B** **C**



Ø 8 mm, T = 22 mm, H = 16,5 mm

132A **B** **C**



Ø 8 mm, T = 14 mm, H = 12 mm

136



Ø 5 mm, T = 12,3 - 16,5 mm, H = 21,5 mm

141B



Ø 4,5 mm, T = 18 mm, H = 11 mm

141C



Ø 4,5 mm, T = 21 mm, H = 11,3 mm

142



Ø 5 mm, T = 6 - 15 mm, H = 18,5 mm

143



Ø 8 mm, T = 13 mm, H = 20,6 mm

144A



Ø 4,2 mm, T = 18,3 mm, H = 21,5 mm

144B



Ø 4,2 mm, T = 18,3 mm, H = 22,5 mm

144C



Ø 4,5 mm, T = 25 - 25 mm, H = 9 mm

CODE	OEM	MODEL	USAGE	Ø (mm)	T (mm)	H (mm)
146, B,D	AUDI, SEAT, SKODA, VW, 443857847B4PK	Audi, Seat, Skoda, VW	Seat Belt Buckle Buttons- Holders Studs Retainer Stopper Rest Pin			
149A,B	A) OEM: VW 3D0864851B41 B) OEM: VW 3D0864200A71N, 3D0864287A	VW Polo, Sharan, Golf V, Seat, Skoda	Floor Carpet Mat Clips			
150A,B,C		Volkswagen, Opel. Fit many models	Trim Panel Clips	6,5	22	21
151	AUDI 8E0868243	Audi A3, A4, A6, A8. Seat, Skoda, VW	Door Trim Panel Retainers	9,5	22 - 25	30
155	VW 6Q0868243	VW Golf Plus, Golf 5, Golf 6, Nuova Polo	Door Trim Panel Retainers	8	22,2	27
156	VW 7H0915450	VW T5, Golf	Engine Battery Cover Screw	5	18,5	24
158A,B		Fits many models:	Lock nut	A) 7 B) 7	12 9,5 - 9,5	12 12
159		VW Passat B5	Trim Panel Clips	8	11,3 - 13	20,5
160	AUDI, VW 3B0867333	VW Amarok (2010>), Bora (1999-2005), Caddy (2004>), Campmob (2004>), Golf (1998-2014>), Jetta (2006-2014), Lupo (1999-2006), Passat (1997>), Phaeton (2002>), Polo (2002>), Sharan (2001-2010), Tiguan (2008-2011), Touran (2003>), Touareg (2003-2010), Transporter (2003>), Audi A1 (2011>), A3 (1997-2003), A8 (2004>)	Trim Clips	5	12 - 14,5	21,5
161		Fits many models	Sun visor holder			
162	VW 1H0853947	VW Golf 3	Side - Under door / Plastic protection of the door (Nut screw in plastic)	6,5	12,3 - 24,6	12
163		VW Sharan, Ford Galaxy, Seat Alhambra	Window Regulator Repair (Left Front)			
164		VW Sharan, Ford Galaxy, Seat Alhambra	Window Regulator Repair (Right Front)			

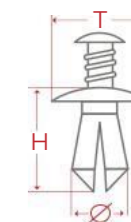

146



149A



150A **B** **C**



Ø 6,5 mm,
T = 22 mm,
H = 21 mm

151



Ø 9,5 mm,
T = 22 - 25 mm,
H = 30 mm

155



Ø 8 mm,
T = 22,2 mm,
H = 27 mm

156



Ø 5 mm,
T = 18,5 mm,
H = 24 mm

158A



A) Ø 7 mm, T = 12 mm, H = 12 mm
B) Ø 7 mm, T = 9,5 - 9,5 mm, H = 12 mm

159



Ø 8 mm,
T = 11,3 - 13 mm,
H = 20,5

160



Ø 5 mm,
T = 12 - 14,5 mm,
H = 21,5 mm

161



162



Ø 6,5 mm,
T = 12,3 - 24,6 mm,
H = 12 mm

163



164



CODE	OEM	MODEL	USAGE	Ø (mm)	T (mm)	H (mm)
165	VW 1K6837200B	VW Golf V	Door Trim Panel Retainers	6,7	12,5	13,5
184	AUDI, VW SKODA, SET 8E0698470	Fits many models	Brake calipers rubber			
187	AUDI, VW, SKODA, SEAT 7L6868243	VW Caddy, Scirocco, Touareg (2003 - 2010), Polo (<2003), Golf Variant (<2009), Transporter (2016>) Beetle (2012), Golf (2009>), Jetta (2011>), Passat (2011>), Polo (2010>), Scirocco (2009>), Sharan (2011>), Touareg (2003>), Transporter (2003>) Skoda Rapid (2012) Alhambra (2011), Leon (2013) Audi A4 (2008<), A 5, Q 5, Q 7, Golf (2013>) A1 (2011>), A4 (2008-2015), A6 (2011>), Q3 (2012>), Q5 (2009), TT (2015>)	Door Panel Clips Trim Trim Door Panel Clips Trim Clips	8	22,5	31
191A		VW, Audi. Fits many models	Pedal rubber			
192	AUDI, VW 4F0825429A	VW Passat (2009-2015). Audi A1, A4 (<2008), A5, A6, A7, RS5 (2010)	Wheel Arch Cover Retainers		22,5	5,8
198		VW, Audi. Fits many models		5	14,2	23,1
214	VOLKSWAGEN AUDI N10516801	VOLKSWAGEN Fits many models. Wheel arch cover, Door panel, Bumper AUDI A4	Nut. Trim. Panel. Door. Grommet Door panel	12	15,4	17
216	VW, AUDI			8,1	21,7	37,9
248	AUDI, VW 8E0825267	VW Golf 4, Passat, Golf Plus, Touran, Golf 5. Ford Mondeo, Cougar Audi A3, A4 2002 >, A4 < 2002	Bumper Clips Wheel arch cover	8,5	20	24
250	VW 3B0868243, 6N3868561	Bora, Golf, Passat, Polo	Door Trim Panel Retainer Clips	10	22	20
251	VW 3A0853575A	VW Passat B5	Side Moulding Clips	8	12 - 16	23
252	VW, SKODA 6K0868243C	VW Touareg (2003-2010)	Door Trim, Trunk, Panel Retainer	7,5	22	22,8
253	VW 1H823397	VW Golf 3, Sharan, Vento	Hood Prop Rod Retainer	7,7	15,4	26
254A,B,C	VW 70186729901C	VW Bora, Caddy, Golf, Passat, Polo, Vento, Phaeton, Transporter	Trim Panel Clips. Transporter: Bumper Clips	8,7	18,5	13,5
256	VW 6N0823397C	Fits many models	Bonnet Holder	6,8	15,3	27,3

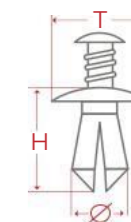

165



Ø 6,7 mm,
T = 12,5 mm,
H = 13,5 mm

184



187



Ø 8 mm,
T = 22,5 mm,
H = 31 mm

191A



192



T = 22,4 mm,
H = 5,8 mm

198



Ø 5 mm,
T = 14,2 mm,
H = 23,1 mm

214



Ø 12 mm,
T = 15,4 mm,
H = 17 mm

216



Ø 8,1 mm,
T = 21,7 mm,
H = 37,9 mm

248



Ø 8,5 mm,
T = 20 mm,
H = 24 mm

250



Ø 10 mm,
T = 22 mm,
H = 20 mm

251



Ø 8 mm,
T = 12 - 16 mm,
H = 23 mm

252



Ø 7,5 mm,
T = 22 mm,
H = 22,8 mm

253



Ø 7 - 7 mm,
T = 15,4 mm,
H = 26 mm

254A **B** **C**



Ø 8,7 mm,
T = 18,5 mm,
H = 13,5 mm

256



Ø 6,8 mm,
T = 15,3 mm,
H = 27,3 mm

CODE	OEM	MODEL	USAGE	Ø (mm)	T (mm)	H (mm)
278A,B	A) OEM: VW 1H586384901C B) OEM: VW 867863849A01C	(A)Passat, Polo, Golf 3, Vento: Seal, Bonnet Retainer. (B) Caddy, Golf, Passat, Polo, Sharan, Vento	Bonnet	12		
279	AUDI, SEAT, SKODA, VW 038103937	Audi: A3 (1996-2003), A4 B5 B6, A6 C4 C5. VW New Beetle, Bora, Caddy (1996-2003), Golf IV, V, Passat B5, B6. Seat Cordoba (1999-2002), Ibiza (1999-2002), Inca, Leon (1999-2005), Toledo (1999-2004)	Engine Cover Cap	38,5	38,5	9,4
280	VW 028103937	Audi A4 B5, A6 C5. Seat Cordoba (1999-2002), Ibiza (1999-2002), Alhambra (1999-2000). VW - Golf III, Vento, Passat B3, B4, B5, Polo (1995-2001), Sharan (1996-2000)	Engine Cover Cap	30	33,5	7,5
281	SKODA, SEAT, VW, AUDI 06A103937	Audi A3 (1996-2003). VW New Beetle, Bora, Golf IV, V, Lupo, Polo (1995-2001), Sharan (1996-2000). Seat Alhambra (1996-2000), Arosa, Cordoba (1999-2002), Ibiza (1999-2002), Leon (1999-2005), (2005-2013), Toledo (1999-2004). Skoda Octavia I	Engine Cover Cap	32	33,5	9
283	AUDI, VW N90335004	Audi, Volkswagen. Fits many models	Metal clamp washer clips engine cover	5	30,4	3
284	AUDI N90796502	Audi, Volkswagen. VW Golf IV, V, Lupo, New Beetle, Polo (>2002) Scirocco (>2009), Touran, Transporter: Audi A3, A4, A5, A6, Q5, Q7. Fits many models	Metal clamp washer clips engine cover	4,5	30	3
320	AUDI, SEAT, SKODA, VW 4A0867276	Audi, VW, Skoda, Seat. Audi A4 B6, A5, Q7 (2005-2009). VW Bora, Golf IV, V, Polo (2001-2005), Passat B6, Tiguan. Seat Ibiza (2002-2008), Leon (1999-2005), (2005-2013), Toledo (1999-2005). Skoda Octavia II, Fabia, Roomster, Superb	Boot door trim clips	6,5	9 -18	22
321	AUDI, VW 3B9867289, SEAT 4A0867276B	Audi, Volkswagen, Skoda, Seat. Audi A4 B6, A5, Q7 (2005-2009). VW Bora, Golf IV, V, Polo (2001-2005), Passat B6, Tiguan. Seat Ibiza (2002-2008), Leon (1999-2005), (2005-2013, Toledo (1999-2005). Skoda Octavia II, Fabia, Roomster, Superb	Boot door trim clips	8	9 - 16	15,7
327B	AUDI, VW 8K0805922A	Fits many models	Engine Cover Clips	4	19x23	9.5
328	AUDI, VW N90974701	Fits many models	Engine Cover, Wheel Arch	4,9	14,3	19
336		Fits many models	Brake Caliper Bleed Screw Rubber Caps	6	11	9

AVAILABLE COLOURS

A B C

DIMENSIONS

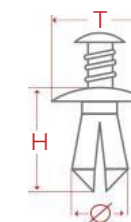

278A



278B



279



Ø 38,5 mm,
T = 38,5 mm,
H = 9,4 mm

280



Ø 30 mm,
T = 33,5 mm,
H = 7,5 mm

281



Ø 32 mm,
T = 33,5 mm,
H = 9 mm

283



Ø 5 mm,
T = 30,4 mm,
H = 3 mm

284



Ø 4,5 mm,
T = 30 mm,
H = 3 mm

320



Ø 6,5 mm,
T = 9 - 18 mm,
H = 22 mm

321



Ø 8 mm,
T = 9 x 16 mm,
H = 15,7 mm

327B



Ø 4 mm,
T = 19 x 23 mm,
H = 9,5 mm

328



Ø 4,9mm,
T = 14,3 mm,
H = 19 mm

336



Ø 6 mm,
T = 11 mm,
H = 9 mm

CODE	OEM	MODEL	USAGE	Ø (mm)	T (mm)	H (mm)
346	AUDI N90642001	Audi A4 B5 B6 B7 (1995-2007). Audi A6, C4, C5 (1993-2005). Audi A8 D2 (1993-2002). Seat EXEO (2008-2014). Skoda Superb Mk1 (2002-2008). VW Passat B5 (1997-2000)	Engine Protection pan clips		15,8	27
352		VW Fits many models	Door Trim Panel Retainers	9	15 - 32,3	18
395	VW 37853575	VW Golf 3	Moulding Clips With Grommet	7	18	22
424	VW, AUDI 4D0611715B	Audi, Volkswagen, Skoda. Fits many models	Brake Line Retaining Spring	16,1	17,2 - 28	4,5
439	VW 1H0853585	VW Golf 3 (1991-1997), Vento	Side Moulding Clips			
440	VW 1H0853585B	VW Golf 3, Vento	Side Moulding Clips			
497	AUDI, VW, BMW, MERCEDES-BENZ					

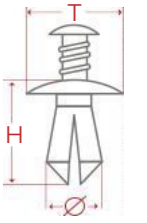

346



T = 15,8 mm,
H = 27 mm

352



Ø 9 mm,
T = 15 - 32,3 mm,
H = 18 mm

395



Ø 7mm,
T = 18 mm,
H = 22 mm

424



Ø 16,1 mm,
T = 17,2 - 28 mm,
H = 4,5 mm

439

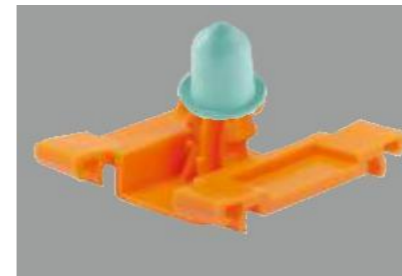

440



497



AUTO BODY CLIPS

AUDI - VW
SEAT - SKODA

1

BMW

17

CITROEN - PEUGEOT
RENAULT

25

FIAT - LANCIA
ALFA ROMEO
IVECO

33

FORD - VOLVO

37

OPEL - DAEWOO
SAAB
GM - CHEVROLET - PONTIAN
CHRYSLER - JEEP

45

MERCEDES BENZ

55

SUBARU - SUZUKI
HYUNDAI - ISUZU - KIA

61

TOYOTA - MAZDA
NISSAN
LEXUS - MITSUBISHI
HONDA - ROVER

67

UNIVERSAL

85

HOSE MENDERS

112

CODE	OEM	MODEL	USAGE	Ø (mm)	T (mm)	H (mm)
03	BMW 51131960054	BMW 3 (1991-1997)	Side Moulding Clips			
04	BMW 51138166675, FIAT 71717421B	BMW Serie 5 (1996-2001), Serie 7 (1995-2002). Fiat Multipla	Side Moulding Clips			
08A,B,C	HONDA 91503SP0003, DAEWOO 94530623, BMW 07130702966	Honda Accord, Civic, CRX, Legend, Prelude, Daewo. BMW E81, E82, E83: Fits many models	Bumper & Trim Clips- Rivet Clips Fasteners Bonnet, Grille etc.	10	20	17
10A,B,C	BMW 51111944537	BMW Serie 3	Bumper Clips	6	20	17
20A,B	MERCEDES BENZ A0009902992, BMW 1916670,VW 16186729901C, N0385491, AUDI 16186729901C, N0385491, FORD 1104880, E844052S	VW Passat, Polo, Vento Golf Bora, Golf, New Beetle, Passat, Polo, Vento, Phaeton, Transporter Audi A3, A4, A6, Ford Escort	Wheel Arch Cover Retainers Panel Retainers Bumper Clips Wheel Arch Cover Retainers	8	16	14
27A,B,C	BMW 51471911992, MERCEDES BENZ A2019900292, VOLVO 30820141, AUDI, VW 447857909	BMW 3'E30, 3'E36, 3'E46, 5'E34, 'E39, 7'E38, 7'E65, X5, Z3, Z8. Mercedes. Fits many models Audi A3 (2013>), A8 (2003-2010) Volvo S40 (2000-2004), S60 (2001-2009), V40 (2000-2004), V70	Trim Panel Clips Trunk Clips Bumper Clips	8	20	18
34A,B,C	BMW 51488181420	BMW 5'E34, 5'E39,7'E23	Interior Trim	8	19	18
36	BMW 51138231130	BMW (1997-2006)	Side Moulding Clips			
43A,B,C		Fits many models	Trim, Trunk, Panel Retainer Clips	7,9	13,6	13
52		BMW	Side Moulding Clips	9	13	13,5
60A,B,C	BMW 51481915964	BMW 518, 520, 524, 525, 528, 535, M5, 840	Trim Panel Clips	7	20	13
80A,C	BMW 51411973500	BMW E34, E36, E38, E39, E50, E70, E71, E36, E34, E39, E38, E53, E70, E52	Trim Panel Clips. Anti-Vibration Rubber Washer	8	14,5 - 18	20
80B,D		BMW E34, E36, E38, E39, E50, E70, E71, E36, E34, E39, E38, E53, E70, E52	Trim Panel Clips. Anti-Vibration Rubber Washer	8	14,5 - 18	20
94	BMW 63120027924	BMW 5 Serie (1996-2001)	Headlight Lamp Adjuster Mounting Bracket (Pre-facelift)			
99	BMW 51711932996	BMW 3, 5, 7, X5, Z3, Z4	Side Moulding Clips	8		

03



04



AVAILABLE COLOURS

A B C

DIMENSIONS

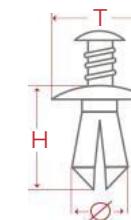

08A B C



Ø 10 mm,
T = 20 mm,
H = 17 mm

10 A B C



Ø 6 mm,
T = 20 mm,
H = 17 mm

20A B



Ø 8 mm,
T = 16 mm,
H = 14 mm

27A B C



Ø 8 mm,
T = 20 mm,
H = 18 mm

34A B C



Ø 8 mm,
T = 19 mm,
H = 18 mm

36



43A B C



Ø 7,9 mm,
T = 13,6 mm,
H = 13 mm

52



Ø 9 mm,
T = 13 mm,
H = 13,5 mm

60A B C



Ø 7 mm,
T = 20 mm,
H = 13 mm

80A



Ø 8 mm,
T = 14,5 - 18 mm,
H = 20 mm

80B



Ø 8 mm,
T = 14,5 - 18 mm,
H = 20 mm

94



99



Ø 8 mm

CODE	OEM	MODEL	USAGE	Ø (mm)	T (mm)	H (mm)
137A,B	ALFA ROMEO, FIAT 51722681, BMW 11500506500/5116188 1149, MITSUBISHI A0009903492, RENAULT 770372126		Plastic Trim Clips, Rivets, Wheel Arch Liner	5,5	16	12
138A,B		BMW Serie 3 Serie 1 (2010>), Serie 2 (2013>), Serie 4 (2013>)	Bumper Clips Wheel arch cover	10	15	17
140A,B,C	BMW 51118174185	BMW Serie 3	Wheel Arch Cover Retainers, Bumper Clips	6	20	17
141A	BMW 16131176747, MERCEDES BENZ A0039900251	Fits many models	Plastic Nuts for Trim	4,5	16	11
141D	BMW 51711958025, MERCEDES BENZ A2019900050		Trim and protections	4,5	24	11,3
152		BMW 39, 5 Series (2000)	Headlight Lamp Adjuster Mounting Bracket (Pre-facelift)			
154A,B		BMW, Peugeot. Fits many models	Plastic Trim Clips, Rivets, Wheel Arch Liner	5	16	14
167A,B		BMW. Fits many models	Trim Panel Clips. PA-6 (extremely flexible). Anti-Vibration Rubber Washer	7,5	18,4	20,4
168A,B		BMW. Fits many models	Trim Panel Clips. PA-6 (extremely flexible). Anti-Vibration Rubber Washer	7,5	18,4	20,4
190A,B		Mercedes. Fits many models	Trim Panel Clips	8	22	24
195A,B	BMW 51418172050	BMW 5'E39, Z8, R61	Door Trim Panel Retainers	8	14,5 - 18	20
199		BMW 3 Compact (1996-2001)	Headlight Lamp Adjuster Mounting Bracket (Pre-facelift)			
213A,B	BMW 51418101204, MERCEDES BENZ A0069885778	BMW E36, E46, E38, E65, E66	Trim Clips. Anti-Vibration Rubber Washer	8	14,5 - 18	19
214	BMW 51127020321	E21, E39, E61, E66, E82, E90, F01, F04, F06, F07, F15, F16, F26, F32, F33, I12	Mounting Trim	12	15,4	17

137A_B



Ø 5,5 mm, T = 16 mm, H = 12 mm

138A_B



Ø 10 mm, T = 15 mm, H = 17 mm

AVAILABLE COLOURS

A **B** **C**

DIMENSIONS

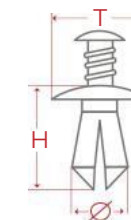

140A_{B,C}



Ø 6 mm, T = 20 mm, H = 17 mm

141A



Ø 4,5 mm, T = 16 mm, H = 11 mm

141D



Ø 4,5 mm, T = 24 mm, H = 11,3 mm

152



154A_B



Ø 5 mm, T = 16 mm, H = 14 mm

167A



Ø 7,5 mm, T = 18,4 mm, H = 20,4 mm

168A



Ø 7,5 mm, T = 18,4 mm, H = 20,4 mm

190A_B



Ø 8 mm, T = 22 mm, H = 24 mm

195A



Ø 8 mm, T = 14,5 - 18 mm, H = 20 mm

199



213A

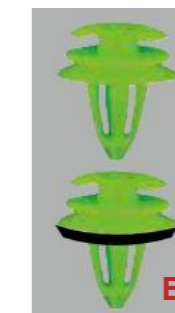

Ø 8 mm, T = 14,5 - 18 mm, H = 19 mm

214



Ø 12 mm, T = 15,4 mm, H = 17 mm

CODE	OEM	MODEL	USAGE	Ø (mm)	T (mm)	H (mm)
255	BMW 51132251394	BMW Serie E36	Side Moulding Clips	8	18 - 30,5	26
274	BMW 51321938884	BMW E36	Interior Plastic Clips for Trims on Sill & Door Entrance Biege Clips	9	29 - 34	14
288	BMW 1437194187	BMW 3 Series (1990-2007), 5 Series (1988-2012), 7 Series (1986-1994), 8 Series (1989-1998), X Series (1998-2012), Z Series (1997-2009)	Panel fasteners holders	4		
296		BMW: 3, 5, 7, Alpina, M3, M5, M6, X3, X5	Engine Undertray Cover Fixing Clips	4,2	18,3	22,3
340A,B	BMW 51418224781	BMW E88, E36, E46, E90, E91, E92, E93, E60, E61, E63, E64, E84, E83, F25, E53, E70, E71, E72, E88, E36, E46, E90, E91, E92, E93, E60, E61, E63, E64, E84, E83	Door Trim Panel. Anti-Vibration Rubber Washer	8	18	22
351	BMW 51477117532	BMW 1' E81, 1' E82, 1' E87, 1' F20, 1' F21, 3' E90, 3' E91, 3' E92, 3' E93, 3' F30, 3' F31, 5' E60, 5' E61, 6' E63, 6' E64, X1 E84, X3 F25, X5 E70, X6 E71, X6 E72	Interior Plastic Clips for Trims on Sill & Door Entrance	19	20	30
354A,B	A) OEM: BMW 51717066226 B) OEM: BMW 51717066229	BMW 1 Series: E82,E88, 3 Series: E21, E30, E36, E46, E90, E91, E92, E93, 6 Series: E24, E63, E64, X Series: E53, E70, E71, E83, Z Series: E52 ,E85, E86, E89	Spacer Clips Plugs for Side Skirt, Sill Moulding, Rocker Cover	A) 6,5 B) 6,5	20	35,7 27,3
355A,B	A) OEM: BMW 07147122912 B) OEM: BMW 07147122913	BMW 1 Series: E82, E88, 3 Series: E21 ,E30, E36, E46, E90, E91, E92, E93, 6 Series: E24, E63, E64, X Series: E53, E70, E71, E83, Z Series: E52, E85, E86, E89	Spacer Clips Plugs for Side Skirt, Sill Moulding, Rocker Cover	A) 11 B) 6,5	22,4 - 30	32,5 35,7
364	BMW 51311938494, 51318177850	BMW Serie 5, Serie 7	Windshield Moulding Clip with Gray Claws		6,5 - 54,4	10,6
497	BMW					

255



Ø 8 mm,
T = 18 - 30,5 mm,
H = 26 mm

274



Ø 9 mm,
T = 29 - 34 mm,
H = 14 mm

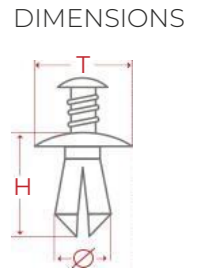

288



Ø 4mm

296



Ø 4,2 mm,
T = 18,3 mm,
H = 22,3 mm

340A



Ø 8 mm,
T = 18 mm,
H = 20 mm

351



Ø 19 mm,
T = 20 mm,
H = 30 mm

354A



A) Ø 6,5 mm, T = 20 mm, H = 35,7 mm
B) Ø 6,5 mm, T = 20 mm, H = 27,3 mm

355A



A) Ø 11 mm, T = 22,4 - 30 mm, H = 32,5 mm
B) Ø 6,5 mm, T = 20 mm, H = 35,7 mm

364



T = 6,5 - 54,4 mm,
H = 10,6 mm

497



AUTO BODY CLIPS



AUDI - VW SEAT - SKODA	1
BMW	17
CITROEN - PEUGEOT RENAULT	25
FIAT - LANCIA ALFA ROMEO IVECO	33
FORD - VOLVO	37
OPEL - DAEWOO SAAB GM - CHEVROLET - PONTIAN CHRYSLER - JEEP	45
MERCEDES BENZ	55
SUBARU - SUZUKI HYUNDAI - ISUZU - KIA	61
TOYOTA - MAZDA NISSAN LEXUS - MITSUBISHI HONDA - ROVER	67
UNIVERSAL	85
HOSE MENDERS	112

CODE	OEM	MODEL	USAGE	Ø (mm)	T (mm)	H (mm)
20A,B		Fits many models	Wheel Arch Cover Retainers	8	16	14
40A,B,C	PEUGEOT 7013J0, CITROEN 8211.WV	Peugeot 307, 607, 807. Citroen C3, C4, C5, C8	Wheel Arch Cover Retainers	8	20	14
41A,B	RENAULT 7701049270, PEUGEOT856540, FIAT 71775718	Renault Nuova Clio, Megane III, Peugeot 106, 206, 306, 806, Partner, 307, 1007, 207, Expert, Citroën Berlingo, Evasion, C 3, C 2, Jumpy III	Side Moulding Clips. Anti-Vibration Rubber Washer	9 - 10	20	15,5
42A,B	PEUGEOT 6991S6, CITROEN 6991S6	Renault Scenic, Peugeot 206, 306, 406, 307, 607, 407, 807, 1007, 207, Ranch, 308, Berlingo, Xsara, C 3, C 5, C 8, C 2, C 4, Xsara II	Door Trim Clips	10 - 11	17,5	18
44A,B	PEUGEOT 6991T3	Peugeot 307	Door Trim Panel Retainers. Anti-Vibration Rubber Washer	10 - 11	17,5	16
47A,B	PEUGEOT, CITROEN 856535	Peugeot 206, Partner Citroën Berlingo, Picasso, Xantia, Xsara	Side Moulding Clips. Anti-Vibration Rubber Washer	10	18	19
49	PEUGEOT 856534	Peugeot 106, 206	Door Side Moulding / Bumpstrip Rubstrip	9 - 10	7,5 - 10	15,5
57A,C		Peugeot, Citroen. Fits many models	Trim clips for Exterior Door Moulding Bumpstrips & Trims. many models: Door Trim Panel Retainers. Anti-Vibration Rubber Washer	7,5 - 8	13 - 17,5	17,6
57B,D		Peugeot, Citroen. Fits many models	Trim clips for Exterior Door Moulding Bumpstrips & Trims. many models: Door Trim Panel Retainers. Anti-Vibration Rubber Washer	7,5 - 8	13 - 17,5	17,6
65A,B	PEUGEOT 856553, OPEL 3636996, LANCIA 51834606, FIAT, ALFA ROMEO 51834606	Peugeot Partner, 307, 207, Ranch, 308. Expert 206, 607, 407, 1007 308 Opel Grandland X 18>, Crossland X 17> Lancia Delta (2008-2014) Fiat 500 L (2012>) Grande Punto (2005)	Wheel Arch Cover Retainers Trim Panel Clips Bumper Clips Wheel Arch Cover Retainers Bumper, Bonnet Front bumper Protections	8	20	16
71	PEUGEOT 6995X3	Peugeot 206, 306	Trim Clips - for Bumpers, Grille trims & Door Side Mouldings	10 - 11	15	14,5

20A **B**



Ø 8 mm, T = 16 mm, H = 14 mm

40A **B C**



Ø 8 mm, T = 20 mm, H = 14 mm

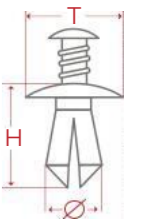

41A



Ø 9 - 10 mm, T = 20 mm, H = 15,5 mm

42A



Ø 10 - 11 mm, T = 17,5 mm, H = 18 mm

44A



Ø 10 - 11 mm, T = 17,5 mm, H = 16 mm

47A



Ø 10 mm, T = 18 mm, H = 19 mm

49



Ø 9 - 10 mm, T = 7,5 - 10 mm, H = 15,5 mm

57A



Ø 7,5 - 8 mm, T = 13 - 17,5 mm, H = 17,6 mm

57B



Ø 7,5 - 8 mm, T = 13 - 17,5 mm, H = 17,6 mm

65A **B**



Ø 8 mm, T = 20 mm, H = 16 mm

71



Ø 10 - 11 mm, T = 15 mm, H = 14,5 mm

CODE	OEM	MODEL	USAGE	Ø (mm)	T (mm)	H (mm)
73	RENAULT 7701044547, PEUGEOT 699786, CITROEN 9619769080	Citroen Xsara, C8, Xsara Picasso, Xsara II	Weatherstrip Clips - For rubber door seals, door gasket clips	3 - 4	8 - 17	11,5
93	PEUGEOT CITROEN 9025j8	Peugeot 308, 3008, 5008 Citroen C 3, C 5, X 7	Rubber Door Seal & Weatherstrip Clips	7,9	20x7	10,7
97	PEUGEOT, CITROEN 6991Y8, RENAULT 7703077469	Renault Clio II - 1998, Clio III - 2005, Megane, Kangoo, Kangoo II. Peugeot 207, 807, Expert III, Partner, Partner Tepee, 407. Door Panel, Trim Citroen C 8, C 2, Jumpy III, Berlingo, C 4 Picasso, C 3 Picasso. Opel Movano (2010>)	Door Panel, Trim Exterior molding clip	12,6	17,4	18,9
100A,B	PEUGEOT, CITROEN 856535	Peugeot 206, Partner. Citroën Berlingo, Picasso, Xantia, Xsara	Trim clips for Exterior Door Moulding Bumpstrips & Trims. Anti-Vibration Rubber Washer	10	18	19
106A,B	PEUGEOT, CITROEN, LEXUS, TOYOTA 9046710161	Peugeot 107, 108, Citroen C1 Toyota Yaris, Corolla, Previa, Verso, Celica, Camry, Hilux, Land Cruiser, MR2, Avensis, Rav 4	Door panel Trim Panel Clips. Anti-Vibration Rubber Washer	8	13 - 18	20,2
109	RENAULT 7703081054	Renault Clio I (1990), Laguna, Logan, R19, R25, R5, Safrane, Supercinque, Twingo	Trim Panel Clips	5	30	17
118A,B	RENAULT 7703077421, IVECO 500326896, OPEL 93160023	Renault Kangoo, Master, Daily	Side Moulding Door Trim Clips. Anti-Vibration Rubber Washer	8	20	16,5
130A,B,C	AUDI VW N90229301, RENAULT 7703072502	Audi VW 100, 200, 80, A6. Renault. Fits many models	Trim, Bonnet Panel Clips	8	22	16,5
131A,B,C	RENAULT 7703077225, PEUGEOT 7518N8, CITROEN 7518N8	Renault Clio I (1990), Espace, Express, Laguna, Master, Megane, Safrane, Supercinque, Twingo, Peugeot, Citroën: Fits many models	Wheel Arch Cover Retainers	9 - 9,5	35	24
134A,B	RENAULT 7703072116	Renault R19, R5. Peugeot, Citroen. Fits many models	Trim Clips	5,5	16	12
135A,B		Fits many models	Wheel Arch Cover Retainers	10 - 11	23	26
137A,B	PEUGEOT 11500506500 RENAULT 770372126	Fits many models	Wheel Arch Cover	5,5	16	12
153A,B	RENAULT, DACIA 7703077435, CITROEN, PEUGEOT 7518N8	Renault Espace, Kangoo, Laguna, Master, Megane, Scenic, Twingo, Vel Satis, Clio III (2005), Clio II (1998), Megane II, Logan, Modus - Renault, Laguna II, Scenic II, Trafic II, Clio IV (2012). Dacia Logan, Duster, Sandero	Bumper Clips	8	35	26

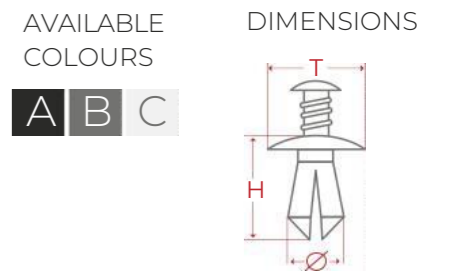

73



Ø 3 - 4 mm, T = 8 - 17 mm, H = 11,5 mm

93



Ø 7,9 mm, T = 20 x 7 mm, H = 10,7 mm

97



Ø 12,6 mm, T = 17,4 mm, H = 18,9 mm

100A



Ø 10 mm, T = 18 mm, H = 19 mm

106A



Ø 8 mm, T = 13 - 18 mm, H = 20,2 mm

109



Ø 5 mm, T = 30 mm, H = 17 mm

118A



Ø 8 mm, T = 20 mm, H = 16,5 mm

130A B C



Ø 8 mm, T = 22 mm, H = 16,5 mm

131A B



Ø 9 - 9,5 mm, T = 35 mm, H = 24 mm

134A B



Ø 5,5 mm, T = 16 mm, H = 12 mm

135A B



Ø 10 - 11 mm, T = 23 mm, H = 26 mm

137A B



Ø 5,5 mm, T = 16 mm, H = 12 mm

153A B



Ø 8 mm, T = 35 mm, H = 26 mm

CODE	OEM	MODEL	USAGE	∅ (mm)	T (mm)	H (mm)
166A,B		Fits many models	Trim Panel Clips	9 - 9,5	23	24
210A,B	CITROEN, PEUGEOT 856548, FIAT 9408565488	Citroen C 4. Fiat Scudo. Peugeot Expert	Side moulding. Anti-Vibration Rubber Washer	9 - 10	22	15,5
226	CITROEN, PEUGEOT 856548, FIAT 71728806	Citroen C4, Expert, Scudo Fiat Ducato '01-06', Boxer, Jumper	Door Trim Clips Side Moulding Rub Bumpstrip Lower Door Trim Clips	8	14 - 20	17
289	SAAB 92152112, RENAULT 7703080096, OPEL 856563	Opel: Astra F, Calibra, Corsa B, Movano A, Movano B, Omega A, Omega B, Tigra A, Vectra A, Vectra, Renault: Master I, Master II. Saab: 9-3 (2002-2012), 9-5 (1995-2010), 900 (1994-1998)	Exhaust Mount Clips		16,3 - 20,3	9
294	PEUGEOT 694383, RENAULT 7703046034	Peugeot, Renault, Volvo. Fits many models		6		
324	PEUGEOT 742723 CITROEN, Renault 7703008162	Citroen, Peugeot, Renault	Screw for Bumper	6	19,3	23,5
348	RENAULT 7703077476, PEUGEOT, CITROEN 9345ZN	Renault Laguna III, Megane III. Peugeot 308 (2007-2013). Citroen C4 Picasso, DS4, DS5	Door Trim Panel Retainers	9,5	17	20
365	RENAULT 7701047661	Renault Megane, Scenic	Side Moulding Door Bump Strip Trim Fastener Clips	6,5	22	20
373	RENAULT 7701049008	Renault Laguna II	Door Trim Panels	5,5	21,5	19,3
384	RENAULT 7701470769	Fits many models	Side Moulding Clips	7	27,5 - 30	14
389	RENAULT 7701040837	Renault Clio II (1998)	Side Moulding Clips	17,8	19	16,5
392		Renault	Side Moulding Clips	8	19,2	15
435	RENAULT 7701040837	Renault Clio	Side Moulding Clips	8	22 - 24,5	18
454	RENAULT 7703077368, 7701050734, 5001855049	Renault Laguna II, Laguna II GT, Megane, Megane GT Scenic, Master I, Master I Bus, Master II, Master II Bus, Kangoo, Kangoo Express, Espace IV, Trafic II	Door Panel Interior Trim	10	15	14,9
495A,B	CITROEN 6991Z1	Citroen: Berlingo C3 C4 C5 C8 Peugeot: 207, 307, 308, 406	Trim Panel Clips. PA-6 (extremely flexible). Anti-Vibration Rubber Washer	10 x 11	17,5	18
496A,B	CITROEN 6991Z1	Citroen: Berlingo C3 C4 C5 C8 Peugeot: 207, 307, 308, 406	Trim Panel Clips. PA-6 (extremely flexible). Anti-Vibration Rubber Washer	10 x 11	17,5	18

166A_B



∅ 9 - 9,5 mm, T = 23 mm, H = 24 mm

210A



∅ 9 - 10 mm, T = 22 mm, H = 15,5 mm

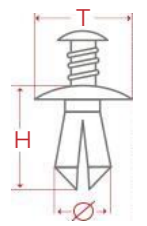

226



∅ 8 mm, T = 14 - 20 mm, H = 17 mm

289



T = 16,3 - 20,3 mm, H = 9 mm

294



∅ 6 mm

324



∅ 6 mm, T = 19,3 mm, H = 23,5 mm

348



∅ 9,5 mm, T = 17 mm, H = 20 mm

365



∅ 6,5 mm, T = 22 mm, H = 20 mm

373



∅ 5,5 mm, T = 21,5 mm, H = 19,3 mm

384



∅ 7 mm, T = 27,5 - 30 mm, H = 14 mm

389



∅ 17,8 mm, T = 19 mm, H = 16,5 mm

392



∅ 8 mm, T = 19,2 mm, H = 15 mm

435



∅ 8 mm, T = 22 - 24,5 mm, H = 18 mm

454



∅ 10 mm, T = 15 mm, H = 14,9 mm

495A



∅ 10 x 11 mm, T = 17,5 mm, H = 18 mm

496A



∅ 10 x 11 mm, T = 17,5 mm, H = 18 mm

AUTO BODY CLIPS



AUDI - VW SEAT - SKODA	1
BMW	17
CITROEN - PEUGEOT RENAULT	25
FIAT - LANCIA ALFA ROMEO IVECO	33
FORD - VOLVO	37
OPEL - DAEWOO SAAB GM - CHEVROLET - PONTIAN CHRYSLER - JEEP	45
MERCEDES BENZ	55
SUBARU - SUZUKI HYUNDAI - ISUZU - KIA	61
TOYOTA - MAZDA NISSAN LEXUS - MITSUBISHI HONDA - ROVER	67
UNIVERSAL	85
HOSE MENDERS	112

CODE	OEM	MODEL	USAGE	Ø (mm)	T (mm)	H (mm)
04	BMW 51138166675, FIAT 71717421B	BMW Serie 5 (1996-2001), Serie 7 (1995-2002). Fiat Multipla	Side Moulding Clips			
29A,B	LANCIA, FIAT, ALFA ROMEO 5988006	Lancia Dedra, Thema. Fiat: Croma, Marengo, Mille, Tempra, Tipo, Uno. Alfa Romeo 145, 146, 155, 164, 75, 90, GTV, Spider	Trim Panel Clips	6,5	15	14
41A,B	FIAT 71775718	Fiat 500 L (2012>), 500	Exterior molding clip. Anti-Vibration Rubber Washer	9 - 10	20	15,5
51	LANCIA, ALFA ROMEO 7739801, IVECO 500382985	Fits many models	Trim Panel Clips	6	14 - 18	20,5
52	BMW		Side Moulding Clips	9	13	13,5
76B	LANCIA, ALFA ROMEO 4264257, IVECO 14215282	Fits many models	Trim and protections	8,5	11 - 11	9,5
91		VW Golf 4, Bora, Skoda Fabia, Seat Ibiza (2002m), Peugeot 607	Window Regulator Repair			
146, B,D	AUDI, BMW, FORD, OPEL 443857847B4PK	Universal	Belt Buckle Buttons-Holders Studs Retainer Stopper Rest Pin			
163		VW Sharan, Ford Galaxy, Seat Alhambra	Window Regulator Repair (Left Front)			
164		VW Sharan, Ford Galaxy, Seat Alhambra	Window Regulator Repair (Right Front)			
210A,B	CITROEN, PEUGEOT 856548, FIAT 9408565488	Citroen C 4. Fiat Scudo. Peugeot Expert	Side moulding. Anti-Vibration Rubber Washer	9 - 10	22	15,5
226	FIAT 71728806	Fiat Ducato (2001-2006), Boxer, Jumper	Side Moulding Rub Bumpstrip / Lower Door Trim Clips	8	14 - 20	17
252	VW, SEAT 6K0868243C	VW Touareg (2003 - 2010) Seat Cordoba, Ibiza	Trunk Door panel	7,5	22	22,8
323	ALFA ROMEO, FIAT, LANCIA 46419734	Alfa Romeo, Fiat, Lancia	Bumper Clips	6	17 - 18	24,7
453	FIAT 00464089536, 8163294AA	Fiat: Brava (1995-2001), Bravo (2007-2017),Doblo (2001-2017), (2005-2010), (2010-2017), Ducato (2002-2006), (1994-2002), Idea (2004-2017), Linea (2007-2017),Marea Multipla Palio, Panda (2003-2012), (2012-2017),Grande Punto (2005-2009), Punto Evo (2009-2011), Punto FI (1999-2017),Lancia Y (1995-2003),Y (2003-2017) Lybra (1999-2007),Kappa (1994-2000) Ypsilon Musa (2004-2012)	Bumper, Door Trim, Body	7,6 x 7,6	16,1	25,4

04



29A^B



Ø 6,5 mm,
T = 15 mm,
H = 14 mm

41A



Ø 9 - 10 mm,
T = 20 mm,
H = 15,5 mm

FIAT - LANCIA - ALFA - ROMEO - IVECO

AVAILABLE COLOURS

A B C

DIMENSIONS

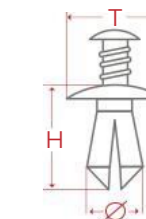

51



Ø 6 mm,
T = 14 - 18 mm,
H = 20,5 mm

52



Ø 9 mm,
T = 13 mm,
H = 13,5 mm

76B



Ø 8,5 mm,
T = 11 - 11 mm,
H = 9,5 mm

91

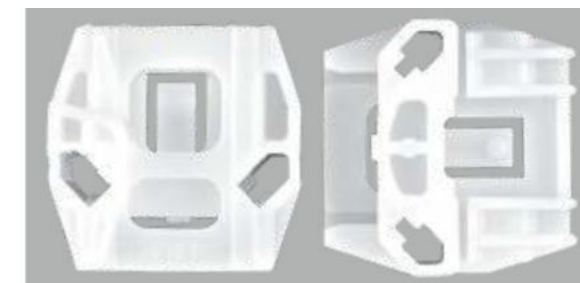

146



B (N)

D (N)

163



164

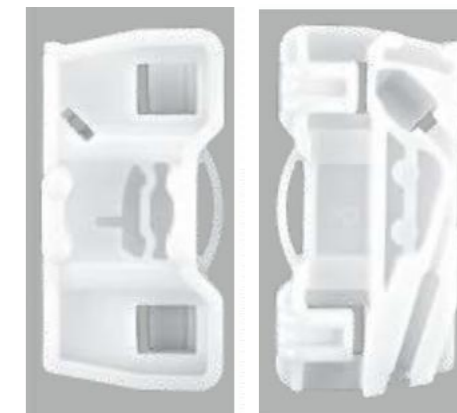

210A



Ø 9 - 10 mm,
T = 22 mm,
H = 15,5 mm

226



Ø 8 mm,
T = 14 - 20 mm,
H = 17 mm

252



Ø 7,5 mm,
T = 22 mm,
H = 22,8 mm

323



Ø 6 mm,
T = 17 - 8 mm,
H = 24,7 mm

453



Ø 7,6 x 7,6 mm,
T = 16,1 mm,
H = 25,4 mm

AUTO BODY CLIPS

AUDI - VW
SEAT - SKODA

1

BMW

17

CITROEN - PEUGEOT
RENAULT

25

FIAT - LANCIA
ALFA ROMEO
IVECO

33

FORD - VOLVO

37

OPEL - DAEWOO
SAAB
GM - CHEVROLET - PONTIAN
CHRYSLER - JEEP

45

MERCEDES BENZ

55

SUBARU - SUZUKI
HYUNDAI - ISUZU - KIA

61

TOYOTA - MAZDA
NISSAN
LEXUS - MITSUBISHI
HONDA - ROVER

67

UNIVERSAL

85

HOSE MENDERS

112

CODE	OEM	MODEL	USAGE	Ø (mm)	T (mm)	H (mm)
18A,B,C		Fits many models	Trim Panel Clips	7 - 8	19	20
19A,B,C		Fits many models	Trim Panel Clips	9 - 10	22	20
20A,B	MERCEDES BENZ A0009902992, BMW 1916670, VW 16186729901C, N0385491, AUDI 16186729901C, N0385491, FORD 1104880, E844052S	VW Passat, Polo, Vento Golf Bora, Golf, New Beetle, Passat, Polo, Vento, Phaeton, Transporter Audi A3, A4, A6. Ford Escort	Wheel Arch Cover Retainers Panel Retainers Bumper Clips Wheel Arch Cover Retainers	8	16	14
24A,B	OPEL 2345957, FORD 1008086	Fits many models	Door Trim Panel Retainers (extremely flexible). Anti-Vibration Rubber Washer	8	13 - 17	20
27A,B,C	BMW 51471911992, MERCEDES BENZ A2019900292, VOLVO 30820141, AUDI VW 447857909	BMW 3'E30, 3'E36, 3'E46, 5'E34, 5'E39, 7'E38, 7'E65, X5, Z3, Z8 Mercedes. Fits many models Audi A3 (2013>), A803 (2010) Volvo S40 (2000-2004), S60 (2001-2009), V40 (2000-2004), V70	Trim Panel Clips Trunk Bamper	8	20	18
32A,B,C	MAZDA, FORD 3827866	Fits many models	Interior Trim Fastener Clips for Trim Panels, Fascias & Linings	6	17,5	12
34A,B,C	FORD 1018434	Ford: Escort, Fiesta	Trim Panel Clips	8	19	18
61A,B	VW 7M0867299K, FORD 1008068	VW Sharan, Transporter, Polo Classic Audi A3, A6, A8. Ford Galaxy	Door Trim Panel Retainers (extremely flexible)	8	13 - 18	21
70A,C		Ford. Fits many models	Door Panel Trim	8	13 - 17	19
70B,D	FORD 703867299	Ford. Fits many models	Trim. Anti-Vibration Rubber Washer	8	13 - 17	19
101	VOLVO 9484284	Volvo C60, C70, S60, S80	Door Sill Clips	8	15 - 18	17
123A,B,C		Chrysler, Ford. Fits many models	Trim Panel Clips	8	22	16
126	FORD N805612S100, GM 10143422		Door Trim Panel Retainer	7,5	13 - 19,5	31
128A,B,C	FORD 100792	Fits many models	Trim Panel Clips	6,5	18	20

18A **B C**



Ø 7 - 8 mm,
T = 19 mm,
H = 20 mm

19A **B C**



Ø 9 - 10 mm,
T = 22 mm,
H = 20 mm

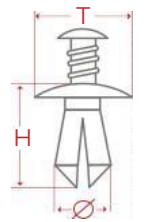

20A **B**



Ø 8 mm,
T = 16 mm,
H = 14 mm

24A



Ø 8 mm,
T = 13 - 17mm,
H = 20 mm

27A **B C**



Ø 8 mm,
T = 20 mm,
H = 18 mm

32A **B C**



Ø 6 mm,
T = 17,5 mm,
H = 12 mm

34A **B C**



Ø 8 mm,
T = 19 mm,
H = 18 mm

61A



Ø 8 mm,
T = 13 - 18 mm,
H = 21 mm

70A



Ø 8 mm,
T = 13 - 17 mm,
H = 19 mm

70B



Ø 8 mm,
T = 13 - 17 mm,
H = 19 mm

101



Ø 8 mm,
T = 15 - 18 mm,
H = 17 mm

123A **B C**



Ø 8 mm,
T = 22 mm,
H = 16 mm

126



Ø 7,5 mm,
T = 13 - 19,5 mm,
H = 31 mm

128A **B C**



Ø 6,5 mm,
T = 18 mm,
H = 20 mm

CODE	OEM	MODEL	USAGE	Ø (mm)	T (mm)	H (mm)
157	VOLVO 9132876	Volvo: S40, S70, V40, V70, XC70, 850	Trim Clips Interior fascia panels boot linings, pillar covers	7,2	11,5 - 12,5	15
163		VW Sharan, Ford Galaxy, Seat Alhambra	Window Regulator Repair (Left Front)			
164		VW Sharan, Ford Galaxy, Seat Alhambra	Window Regulator Repair (Right Front)			
218	VOLVO 8679426	Volvo: S40, V50, C70, C30 (2004 -2013)	Door Trim Panel Retainers	8	22,5	31
248	VW, AUDI, SEAT 8E0825267, RENAULT 7701049271, OPEL 4803228, FORD 1039463	VW Golf 4, Passat, Golf Plus, Touran, Golf 5 Seat Ibiza (> 2002), Leon, Audi A3, A4 (2002 >), A4 (< 2002), Land Rover Discovery (2005-2009), Range Rover Sport (2005-2010) Renaul Scenic Opel Antara (2012-2017) Ford Mondeo, Cougar	Covering under body Wheel arch cover Trim Underbody Bumper	8,5	20	24
275	VOLVO 3923712	Volvo	Hood Prop Rod Retainer	8,5	16,5 - 21,7	19,5
277	FORD 1038008	Ford KA	Molding side	7,5	20,5	18,5
283	AUDI, VW N90335004, FORD6715468	Audi, Volkswagen. Fits many models Ford Transit, Mondeo, Sierra, Scorpio, C-MAX, Escort, Focus (1998-2005), Mondeo, Puma, Transit, Cougar, Granada, Scorpio	Metal clamp washer clips engine cover Bumper	5	30,4	3
295	FORD 608980, MERCEDES-BENZ A0039941545	Ford, Mercedes-Benz. Fits many models		8		
332	FORD 1257376	Ford Focus (2004), C-MAX (2003-2007)	Door Panel	8	18	28,5
337	FORD W704958S300	Ford. Fits many models	Door Trim Panel Retainers	9,2	23,1	31,7
338		Ford. Fits many models	Door Trim Panel Retainers	9,2	23,1	31,7
372	FORD 2T14V35312AB	Ford Connect	Wheel Arch Trim Plastic Clips	9,5	12 - 20	16,2

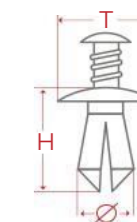

157



Ø 7,2 mm,
T = 11,5 - 12,5 mm,
H = 15 mm

163

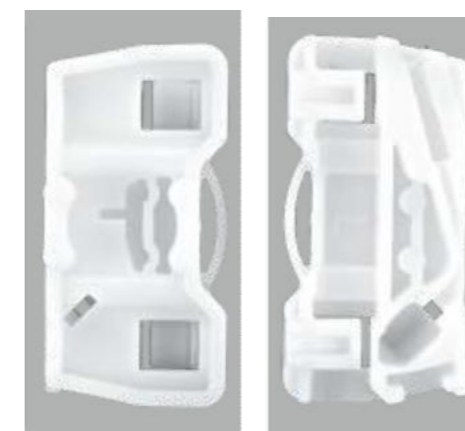

164

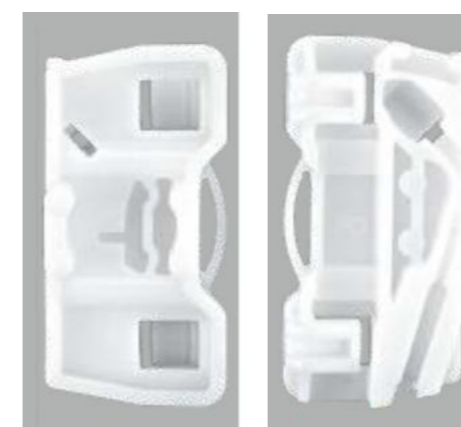

218



Ø 8 mm,
T = 22,5 mm,
H = 31 mm

248



Ø 8,5 mm,
T = 20 mm,
H = 24 mm

275



Ø 8,5 mm,
T = 16,5 - 21,7 mm,
H = 19,5 mm

277



Ø 7,5 mm,
T = 20,5 mm,
H = 18,5 mm

283



Ø 5 mm,
T = 30,4 mm,
H = 3 mm

295



Ø 8 mm

332



Ø 8 mm,
T = 18 mm,
H = 28,5 mm

337



Ø 9,2 mm,
T = 23,1 mm,
H = 31,7 mm

338



Ø 9 mm,
T = 20 mm,
H = 32,3 mm

372



Ø 9,5 mm,
T = 12 - 20 mm,
H = 16,2 mm

CODE	OEM	MODEL	USAGE	Ø (mm)	T (mm)	H (mm)
398	FORD N804759S	Ford. Fits many models	Blind Rivet Front Bumper Cover Clip	6,1	16,9	56,6
399	CHRYSLER 4370138, 6503860, FORD N804675S	Chrysler, Ford, Fits many models	Blind Rivet Front Bumper Cover Clip	6,4	16,9	54
401	GM 10184895, 20452072, FORD N803862-S, CHRYSLER 6501559	GM, Ford, Chrysler. Fits many models	Blind Rivet Front Bumper Cover Clip	6	13	55
421	LAND ROVER DKP5279L, FORD W701194 S300 6696122	Land Rover: (1989-2004). Ford: Transit (1994-2000)	Rear Door Trim Panel - Door Card Stud	5,7	12,4	22,3
443	VOLVO 30784514	S80, V70, XC70, XC90	Door Moulding	7,9	17,1 x 15,1	17,2
444	VOLVO 30624192	V40, V60, S60	Trim Clips for Side Skirts, Sill Mouldings & Rocker Cover Trim	7,9	17,1	15,9
445	FORD 4855809	FORD Fiesta 2008 >, Focus 2011, C-MAX 2011, Mondeo 2007 >, Ranger 2012, Galaxy 2006 Fiesta 2008 >, Focus 2011, C-MAX 2011, Mondeo 2007 >, Ranger 2012, Galaxy 2006 Fiesta 2008 >, Focus 2011, C-MAX 2011, Mondeo 2007 >, Ranger 2012, Galaxy 2006	Bumper Wheel arch cover Trim	6,5	17,8	20,3
446	FORD W713331S300	Fits many models	Grille Retainer	6,2	17,9	24,9
450	FORD W708530S300	Explorer 2007-2010	Bumper Clips	8	20	29
457	VOLVO 31214496	Volvo S40, S80, V70, XC60, XC70	Rocker Molding Clips			

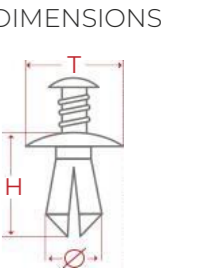

398



Ø 6,1 mm,
T = 16,9 mm,
H = 57,6 mm

399



Ø 6,4 mm,
T = 16,9 mm,
H = 54 mm

401



Ø 6 mm,
T = 13 mm,
H = 55 mm

421



Ø 5,7 mm,
T = 12,4 mm,
H = 22,3 mm

443



Ø 7,9 mm,
T = 17,1 x 15,1 mm,
H = 17,2 mm

444



Ø 7,9 mm,
T = 17,1 mm,
H = 15,9 mm

445



Ø 6,5 mm,
T = 17,8 mm,
H = 20,3 mm

446



Ø 6,2 mm,
T = 17,9 mm,
H = 24,9 mm

450



Ø 8 mm,
T = 20 mm,
H = 29 mm

457

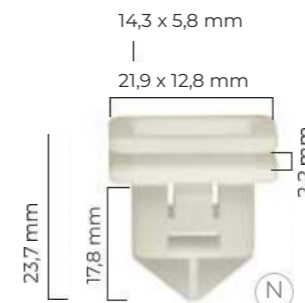

AUTO BODY CLIPS



AUDI - VW SEAT - SKODA	1
BMW	17
CITROEN - PEUGEOT RENAULT	25
FIAT - LANCIA ALFA ROMEO IVECO	33
FORD - VOLVO	37
OPEL - DAEWOO SAAB GM - CHEVROLET - PONTIAN CHRYSLER - JEEP	45
MERCEDES BENZ	55
SUBARU - SUZUKI HYUNDAI - ISUZU - KIA	61
TOYOTA - MAZDA NISSAN LEXUS - MITSUBISHI HONDA - ROVER	67
UNIVERSAL	85
HOSE MENDERS	112

CODE	OEM	MODEL	USAGE	Ø (mm)	T (mm)	H (mm)
08A,B,C	HONDA 91503SP0003, DAEWOO 94530623, BMW 07130702966	Honda Accord, Civic, CRX, Legend, Prelude, Daewo. BMW E81, E82, E83. Fits many models	Bumper & Trim Clips- Rivet Clips Fasteners Bonnet, Grille etc.	10	20	17
20A,B,C	MERCEDES BENZ A0009902992, BMW 1916670, VW 16186729901C, N0385491, AUDI 16186729901C, N0385491, FORD 1104880, E844052S, OPEL 090087290	WV Passat, Polo, Vento, Audi A3, A4, A6, Ford Escort, Opel Ascona, Corsa, Kadett Golf Bora, Golf, New Beetle, Passat, Polo, Vento, Phaeton, Transporter	Wheel Arch Cover Retainers Panel Retainers Bumper Clips	8	16	14
24A,B	OPEL 2345957	Opel Astra, Corsa, Tigra, Vectra, Zafira	Door Trim Panel Retainers (extremely flexible). Anti-Vibration Rubber Washer	8	13 - 17	20
53	OPEL 2240587	Opel Corsa	Door Trim Panel Retainers	7,5	17,5	18
54A,B		Fits many models	Hood Insulation Retainers	7 - 9	26	10
59	TOYOTA 9018906028, 9018906188, 9018906212	Toyota	Wheel Arch Cover Retainers	8	20,5	24,7
118A,B	RENAULT 7703077421, IVECO 500326896, OPEL 93160023, 7701470779	Renault Kangoo, Master, Daily. Opel Vivaro	Side Moulding Door Trim Clips. Anti-Vibration Rubber Washer	8	20	16,5
122	GM 94852368		Bumper	8	20,1	36,5
123A,B		Chrysler, Ford. Fits many models	Trim Panel Clips	8	22	16
125	OPEL 1180216	Opel Calibra (1989-1997), Corsa B (1993-2001), Omega A (1987-1993), Omega B (1994-2003), Vectra A (1989-1995)	Hood Prop Rod Retainer	7	16	25
126	FORD N805612S100, GM 10143422		Door Trim Panel Retainer	7,5	13 - 19,5	31
127	GM 10421018	Fits many models	Door Trim Panel Retainer	7	18 - 21,5	40,2
129A,B	DAEWOO 094090831	Daewoo Lanos, Leganza, Nubira	Panel and Trim Retainer. Anti-Vibration Rubber Washer	8,5	13 - 16,5	18,7
142	OPEL 157979, 90579619	Opel Corsa (2007)	Weatherstrip Clip for rubber door seals, door gasket clips	5	6 - 15	18,5
170A,B,C		Fits many models	Trim Panel Clips	8	19	14,6

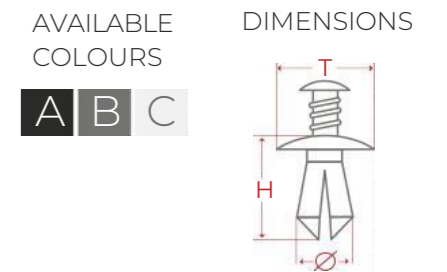

08A^BC



Ø 10 mm,
T = 20 mm,
H = 17 mm

20A^BC



Ø 8 mm,
T = 16 mm,
H = 14 mm

24A



Ø 8 mm,
T = 13 - 17mm,
H = 20 mm

53



Ø 7,5 - 8 mm,
T = 17,5 mm,
H = 18 mm

54A^B



Ø 7 - 9 mm,
T = 20,5 mm,
H = 10 mm

59



Ø 8 mm,
T = 20,5 mm,
H = 24,7 mm

118A



Ø 8 mm,
T = 20 mm,
H = 16,5 mm

122



Ø 8 mm,
T = 20,1 mm,
H = 36,5 mm

123A^BC



Ø 8 mm,
T = 22 mm,
H = 16 mm

125



Ø 7 mm,
T = 16 mm,
H = 25 mm

126



Ø 7,5 mm,
T = 13 - 19,5 mm,
H = 31 mm

127



Ø 7 mm,
T = 18 - 21,5 mm,
H = 40,2 mm

129A



Ø 8,5 mm,
T = 13 - 16,5 mm,
H = 18,7 mm

142



Ø 5 mm,
T = 6 - 15 mm,
H = 18,5 mm

170A^BC



Ø 8 mm,
T = 19 mm,
H = 14,6 mm

CODE	OEM	MODEL	USAGE	Ø (mm)	T (mm)	H (mm)
188A,B		Opel. Fits many models	Trim Panel Clips	6	15	24
189A,B		Opel. Fits many models	Trim Panel Clips	6	20	24
191B		Opel. Fits many models	Pedal rubber			
191C		Opel. Fits many models	Pedal rubber			
240A,B	TOYOTA, LEXUS 9046710167, GM, PONTIAC 88970345	Toyota Corolla, 4Runner (2013>), CH-R (2016>), FJ Cruiser (2007-2014), Prius (2013>), Rav 4 (1999>), Yaris (2006>), Land Cruiser (2008>)	Trim Clips Anti-Vibration Rubber Washer	8,5	18	20
236A,B	OPEL 2345959, 90457899	Opel Corsa C, Meriva A, Omega A, Omega B, Signum, Tigra B, Vectra A, Vectra B, Vectra C	Trim Panel Clips (extremely flexible). Anti-Vibration Rubber Washer	8	13 - 17	20
237	DAEWOO 94530624	Fits many models	Bumper Retainer Screw Fit Plastic Fasteners	10	20	26
293	GM 11503714	Chrysler, Ford, GM. Fits many models.		6		
315	GM 11501188	Fits many models: Chevy / Fords		8	24	35,5
353	GM 15221959	Chevrolet Cobalt & HHR (2005 - 2006)	Panel Moulding Clip	10	15 - 29	21
359	GM 11518988	GM, Buick Enclave, Chevrolet SSR, GMC Acadia, Hummer H3, S & T Truck 2002	Spoiler & Roof Rack Moulding Clip	10	12 - 21	21,6
370	OPEL 90481595, 174854	Astra G, Corsa B, Signum, Tigra A, Vectra B	Moulding Clips	7	16	20,5

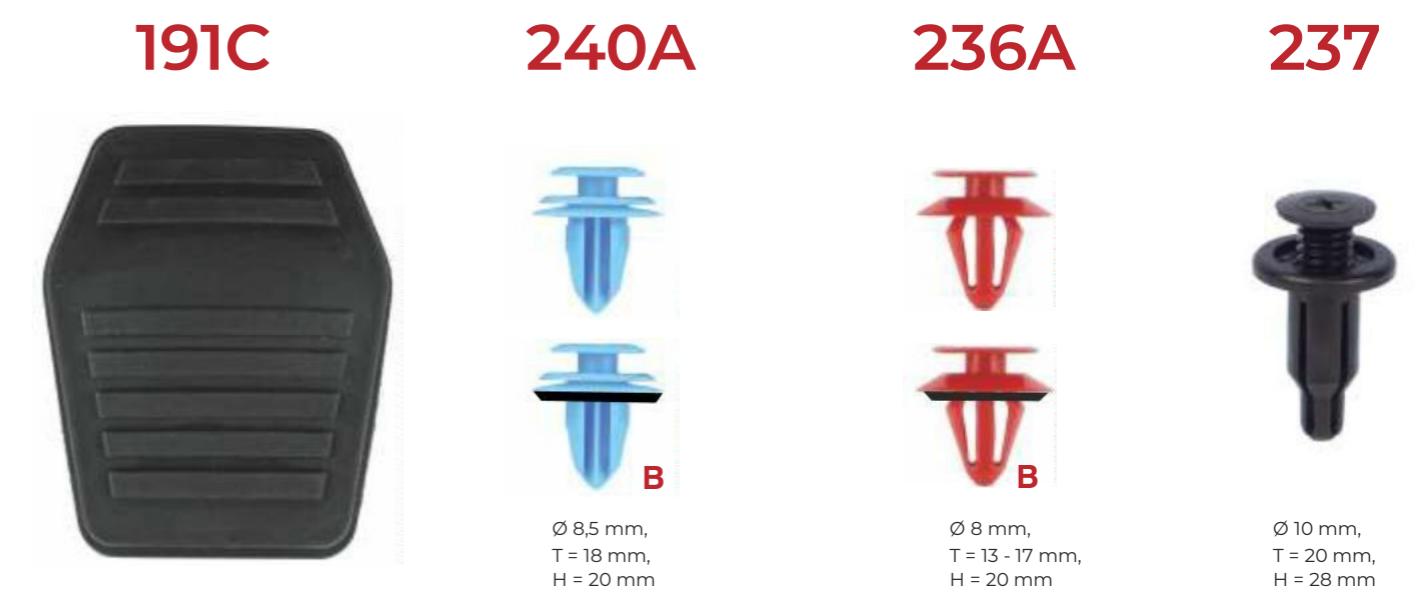
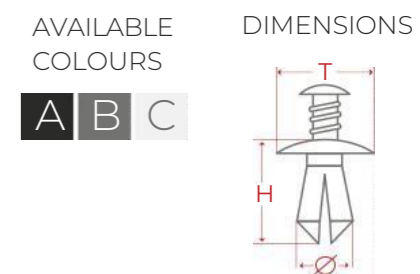

CODE	OEM	MODEL	USAGE	Ø (mm)	T (mm)	H (mm)
377	GM 25693852	GM Buick, Chevrolet, Pontiac	Panel Moulding Clips	10	16,3 - 19,8	20
381	GM 10443956	GM Chevrolet	Panel Moulding Clips	11,5	20 - 21	20
383	CHRYSLER 6505292AA	Chrysler Grand Voyager (2000), Door Trim Panel Pacifica (2004-2008), Town & Country (2012-2016)	Door Trim Panel	7,5	20	20,6
385	GM 10323057	Buick: Allure, LaCrosse; Cadillac: CTS; Chevrolet: Impala; Hummer: H2; Pontiac: G6, Grand Prix, Saturn: Aura	Moulding Clip	7	12 - 20	19,6
415	GM 11518357	Chevrolet Avalanche (2002)	Panel Moulding Clips	10	20 - 21,3	20
433	GM 11569920	Buick Enclave, Cadillac CTS Chevrolet Traverse & GMC Acadia (2003)	Moulding Clip	8	15,2	18,5
434	GM, CHEVROLET, CHRYSLER 22600612	Fits many models	Trim Panel Retainer Clips	8	18	28,5
436	GM 11571175	Fits many models	Moulding Clip	11,4	12 - 20	16
441	GM 88970767	Fits many models	Hood & front fender	6,5	18,1	17,3
445	OPEL 4811301, CHRYSLER 6508863AA	Opel Astra, Zefira, Chrysler 200, 2017 C, LX, Limited, S, Pacifica 2020, 2019, 2018 Hybrid Limited, Hybrid Touring, Hybrid Touring L, Limited, Touring, Touring L, Touring L Plus.	Fender Liner Push Pin Bumper	6,5	17,8	20,3
446	GM 11589291	Fits many models	Grille Retainer	6,2	17,9	24,9
447	GM 14074081	Fits many models	House Hood Seal Retainer Clips	8 x 7,6	19,4	37,7
448	GM 363137	Fits many models	Door Trim Panel	7,8	19	29
449	GM 11561368, CHRYSLER 06508712AA	GM, Chrysler; Chevy Impala, Monte Carlo, Pontiac Grand Prix, Solstice 2004, Jeep Wrangler 2000	Fender Wheel and Bumper	9,3	18	32,2
450	GM 11518017, FORD W708530S300	GM 2009-2012, FORD Explorer 2007-2010. Fits many models	Bumper Clips	8	20	29
451	GM 11589293, OPEL 1816589	Fits many models	Wheel Arch Linings, Bumper Clips	8	19,9	24,4
454	RENAULT 7703077368, 7701050734, 5001855049. OPEL 4414720, LAND ROVER DYC101420	Renault: Fits many models. Opel Vivaro. LAND ROVER Discovery (2005>), Range Rover (2005>)	Panel, Wheel Arch Clips	10	12,4 - 15	14,9

377



Ø 10 mm,
T = 16,3 - 19,8 mm,
H = 20 mm

381



Ø 11,5 mm,
T = 20 - 21 mm,
H = 20 mm

383



Ø 7,5 mm,
T = 20 mm,
H = 20,6 mm

AVAILABLE COLOURS
A B C

DIMENSIONS

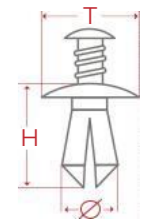

385



Ø 7 mm,
T = 12 - 20 mm,
H = 19,6 mm

415

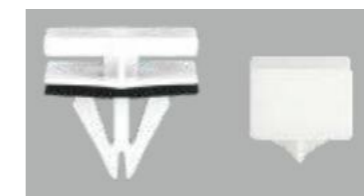

Ø 10 mm,
T = 20 - 21,3 mm,
H = 20 mm

433



Ø 8 mm,
T = 15,2 mm,
H = 18,5 mm

434



Ø 8 mm,
T = 18 mm,
H = 28,5 mm

436



Ø 11,4 mm,
T = 12 - 20 mm,
H = 16 mm

441



Ø 6,5 mm,
T = 18,1 mm,
H = 17,3 mm

445



Ø 6,5 mm,
T = 17,8 mm,
H = 20,3 mm

446



Ø 6,2 mm,
T = 17,9 mm,
H = 24,9 mm

447



Ø 8 x 7,6 mm,
T = 19,4 mm,
H = 37,7 mm

449



Ø 9,3 mm,
T = 18 mm,
H = 32,2 mm

450



Ø 8 mm,
T = 20 mm,
H = 29 mm

451



Ø 8 mm,
T = 19,9 mm,
H = 24,4 mm

454



Ø 10 mm,
T = 12,4 - 15 mm,
H = 14,9 mm

CODE	OEM	MODEL	USAGE	Ø (mm)	T (mm)	H (mm)
399	CHRYSLER 4370138, 6503860, FORD N804675S	Fits many models	Blind Rivet Front Bumper Cover Clip	6,4	16,9	54
400	GM 10109689, 12337915	Fits many models	Blind Rivet Front Bumper Cover Clip	6,4	18	54
401	GM 10184895, 20452072, FORD N803862-S, CHRYSLER 6501559	Fits many models	Blind Rivet Front Bumper Cover Clip	6	13	55
402	GM 20612732	Fits many models	Blind Rivet Front Bumper Cover Clip	4,8	9	49
403	GM 20423647, FORD N804189S	Fits many models	Blind Rivet Front Bumper Cover Clip	5	6,5	47,4
404	CHRYSLER 6500898	Fits many models	Blind Rivet Front Bumper Cover Clip	4,9	7,3	51,6
405	CHRYSLER, JEEP, DODGE 34201631	Fits many models	Blind Rivet Front Bumper Cover Clip	6	17	55
406	GM 20421672, 15955172	Fits many models	Blind Rivet Front Bumper Cover Clip	6,5	13	47
458	GM 363137	Fits many models	Door Trim Panel	7,8	19	29
460	GM 11589295	460GM Cadillac SRX Camaro GMC Sierra 1500	Rear Bumper Mud Guard Retainer	10	24	34

399



Ø 6,4 mm,
T = 16,9 mm,
H = 54 mm

400



Ø 6,4 mm,
T = 18 mm,
H = 54 mm

AVAILABLE COLOURS
A B C

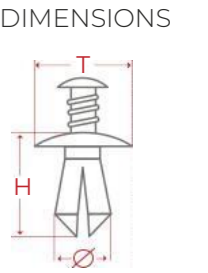

401



Ø 6 mm,
T = 13 mm,
H = 55 mm

402



Ø 4,8 mm,
T = 9 mm,
H = 49 mm

403



Ø 5 mm,
T = 6,5 mm,
H = 47,4 mm

404



Ø 4,9 mm,
T = 7,3 mm,
H = 51,6 mm

405



Ø 6 mm,
T = 17 mm,
H = 55 mm

406



Ø 6,5 mm,
T = 13 mm,
H = 47 mm

458



Ø 7,8 mm,
T = 19 mm,
H = 29 mm

460



Ø 10 mm,
T = 24 mm,
H = 34 mm

Auto BODY CLIPS



AUDI - VW SEAT - SKODA	1
BMW	17
CITROEN - PEUGEOT RENAULT	25
FIAT - LANCIA ALFA ROMEO IVECO	33
FORD - VOLVO	37
OPEL - DAEWOO SAAB GM - CHEVROLET - PONTIAN CHRYSLER - JEEP	45
MERCEDES BENZ	55
SUBARU - SUZUKI HYUNDAI - ISUZU - KIA	61
TOYOTA - MAZDA NISSAN LEXUS - MITSUBISHI HONDA - ROVER	67
UNIVERSAL	85
HOSE MENDERS	112

CODE	OEM	MODEL	USAGE	Ø (mm)	T (mm)	H (mm)
20A,B	MERCEDES BENZ A0009902992, BMW 1916670, VW 16186729901C, N0385491, AUDI 16186729901C, N0385491, FORD 1104880, E844052S	VW Passat, Polo, Vento Audi A3, A4, A6, Ford Escort Golf Bora, Golf, New Beetle, Passat, Polo, Vento, Phaeton, Transporter	Wheel Arch Cover Panel Clips Bumper Clips	8	16	14
22A,B,C	MERCEDES BENZ A1249900492	Mercedes Benz Serie C200, W124, W204, W251C 200 GLA156 (2014>) Vito W639 (2016>)	Wheel Arch Cover / Fender Lining	6,5 - 7	16	19
27A,B,C	BMW 51471911992, MERCEDES BENZ A2019900292, VOLVO 30820141, AUDI-VW 447857909	BMW 3'E30, 3'E36, 3'E46, 5'E34, 5'E39, 7'E38, 7'E65, X5, Z3, Z8. Mercedes Benz Audi A3 (2013>), A8 (2003-2010) Volvo S40 (2000-2004), S60 (2001-09), V40 (2000-2004), V70	Trim Panel Clips Trunk Clips Bumper Clips	8	20	18
38 38A,B	A) MERCEDES BENZ A0019887681	Mercedes Benz 210	Side Moulding Clips	8,5	10 - 16	
50A,C	MERCEDES BENZ A0039884178	Fits many models	Door Trim Panel Retainers. <i>Anti-Vibration Rubber Washer</i>	8	13 - 17,5	19
50B,D	D) MERCEDES BENZ A0119887678	Fits many models	Door Trim Panel Retainers. <i>Anti-Vibration Rubber Washer</i>	8	13 - 17,5	19
64 64A,B		Mercedes Benz	Side Moulding Clips	8,5	12 - 15	
66A,B		Fits many models	Trim Panel Clips	6,5	16	13,5
68 68A,B		Mercedes Benz	Side Moulding Clips	8,5	10 - 12	
141A	MERCEDES BENZ A0039900251	Fits many models	Plastic Nuts for Trim	4,5	16	11
141D	BMW 51711958025, MERCEDES BENZ A2019900050	Fits many models	Trim and protections	4,5	24	11,3

AVAILABLE COLOURS
A B C

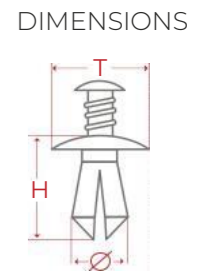

20A^B



Ø 8 mm,
T = 16 mm,
H = 14 mm

22A^{B,C}



Ø 6,5 - 7 mm,
T = 16 mm,
H = 19 mm

27A^{B,C}



Ø 8 mm,
T = 20 mm,
H = 18 mm

38



Ø 8,5 mm,
T = 10 - 16 mm



50A



Ø 8 mm,
T = 13 - 17,5 mm,
H = 19 mm

50B



Ø 8 mm,
T = 13 - 17,5 mm,
H = 19 mm

64A



Ø 8,5 mm,
T = 12 - 15 mm

66A^B



Ø 6,5 mm,
T = 16 mm,
H = 13,5 mm

68



Ø 8,5 mm,
T = 10 - 12 mm

141A



Ø 4,5 mm,
T = 16 mm,
H = 11 mm

141D



Ø 4,5 mm,
T = 24 mm,
H = 11,3 mm

CODE	OEM	MODEL	USAGE	Ø (mm)	T (mm)	H (mm)
213A,B	BMW 51418101204, MERCEDES BENZ A0069885778	BMW E36, E46, E38, E65,E66. Mercedes R129, W203, W221, 901, 906	Trim. Anti-Vibration Rubber Washer	8	14,5 - 18	19
215	MERCEDES BENZ 0019974290			7x7	11,9	119,4
229A,B		Fits many models	Door Trim Panel Retainers. Anti-Vibration Rubber Washer	8	17	19
295	FORD 608980, MERCEDES BENZ A0039941545	Fits many models		8		
327		Mercedes Benz				
342	MERCEDES BENZ 19884481	190, 201	Side Moulding Clips	7,3	12 - 16	16,2
343	MERCEDES BENZ 19886081	190, 201	Side Moulding Clips	7	12 - 5	15,8
407	MERCEDES BENZ 1149970290	Fits many models		7,5	12	160
420	MERCEDES BENZ A1249900972	W124, W201	Side Moulding Clips	7,5 - 8	10,7 - 13,41	21,8
497						

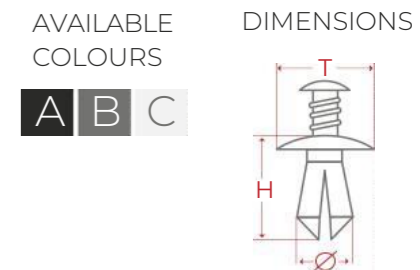

213A



Ø 8 mm,
T = 14,5 - 18 mm,
H = 19 mm

215



Ø 7 x 7 mm,
T = 11,9 mm,
H = 119,4 mm

229A



Ø 8 mm,
T = 17 mm,
H = 19 mm

295



Ø 8 mm

342



Ø 7,3 mm,
T = 12 - 16 mm,
H = 16,2 mm

343

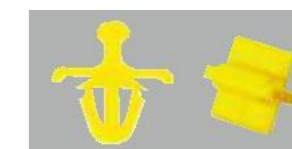

Ø 7 mm,
T = 12 - 5 mm,
H = 15,8 mm

407



Ø 7,5 mm,
T = 12 mm,
H = 160 mm

420



Ø 7,5 - 8mm,
T = 10,7 - 13,41 mm
H = 21,8 mm

497



AUTO BODY CLIPS



AUDI - VW SEAT - SKODA	1
BMW	17
CITROEN - PEUGEOT RENAULT	25
FIAT - LANCIA ALFA ROMEO IVECO	33
FORD - VOLVO	37
OPEL - DAEWOO SAAB GM - CHEVROLET - PONTIAN CHRYSLER - JEEP	45
MERCEDES BENZ	55
SUBARU - SUZUKI HYUNDAI - ISUZU - KIA	61
TOYOTA - MAZDA NISSAN LEXUS - MITSUBISHI HONDA - ROVER	67
UNIVERSAL	85
HOSE MENDERS	112

CODE	OEM	MODEL	USAGE	Ø (mm)	T (mm)	H (mm)
72	HYUNDAI 8777028000	Fits many models	Side Moulding Clips	5,5	18,5	18,5
185	HYUNDAI 877563E500 KIA	Fits many models	Moulding Clips	11	12 - 20	14,5
227	HYUNDAI	Fits many models	Moulding Clips	10,5	24	19,8
230	HYUNDAI 8775638000, KIA	Carnival, Cerato, Getz, Magentis, Rio, Sonata, Spectra	Moulding Clips	10,5 - 12	19 x 13,8	13,9
231	HYUNDAI 877583D000	Hyundai Accent, Elantra, Sonata, Santa Fe	Side Moulding Clips	10,5 - 12	19,6 - 15,8	14,7
232	KIA 877562E000	Kia Santa Fe, Tucson	Side Moulding Clips	10,5 - 12	19 - 13,7	14,5
233	HYUNDAI, KIA 8775835000	Hyundai Atos Prime, Santa Fe. Kia, Picanto	Side Moulding Clips	10,5 - 12	19 - 11	14,4
259	ISUZU 8973599420	Isuzu D-Max Colorado & Rodeo	Mould Flare Clip	8	17	24
261	HYUNDAI 87702H1000	Hyundai Terracan. Fits many models	Side Moulding Clips	9	16	16,7
269		Hyundai, Elantra, Lantra, Matrix, Sonata, Tiburon, Tucson	Trim Panel Clips	11	16	26
271		Hyundai. Fits many models	Side Moulding Clips	9	18	18
273			Side Moulding Clips	7	18	15,7
276		Fits many models	Trim Panel Clips	8,5	18,2	22,6
344	HYUNDAI 8775634500	Fits many models	Side Moulding Clips	7,8	7,2 x 7,2	6,9

72



Ø 5,5 mm,
T = 18,5 mm,
H = 18,5 mm

185



Ø 11 mm,
T = 12 - 20 mm,
H = 14,5 mm

AVAILABLE
COLOURS

A B C

DIMENSIONS

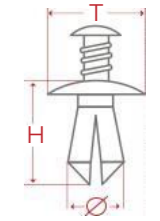

227



Ø 10,5 mm,
T = 24 mm,
H = 19,8 mm

230



Ø 10,5 - 12 mm,
T = 19 x 13,8 mm,
H = 13,9 mm

231



Ø 10,5 - 12 mm,
T = 19,6 - 15,8 mm,
H = 14,7 mm

232



Ø 10,5 - 12 mm,
T = 19 - 13,7 mm,
H = 14,5 mm

233



Ø 10,5 - 12 mm,
T = 19 - 11 mm,
H = 14,4 mm

259



Ø 8 mm,
T = 17 mm,
H = 24 mm

261



Ø 9 mm,
T = 16 mm,
H = 16,7 mm

269



Ø 11 mm,
T = 16 mm,
H = 26 mm

271



Ø 9 mm,
T = 18 mm,
H = 18 mm

273



Ø 7 mm,
T = 18 mm,
H = 15,7 mm

276



Ø 8,5 mm,
T = 18,2 mm,
H = 22,6 mm

344



Ø 7,8 mm,
T = 7,2 x 7,2 mm,
H = 6,9 mm

CODE	OEM	MODEL	USAGE	Ø (mm)	T (mm)	H (mm)
363	HYUNDAI 858153310	Hyundai. Fits many models	Side Moulding Clips	7,5	17	17
366	HYUNDAI 87703H100	Hyundai. Fits many models	Side Moulding Clips	6	15 - 22	13
369	HYUNDAI 8112637010	Hyundai, Elantra, Lantra, Matrix, Sonata, Tiburon, Tucson	Trim Panel Clips	11	26	16
371A	HYUNDAI 8213222100	Fits many models	Side Moulding Clips	5,6	5,4 - 14,4	14,1
390	HYUNDAI, KIA 8775837000	Hyundai Sonata (> 1999), Kia Optima & Sorrento Hyundai, Kia (> 2001)	Side Moulding Clips	11	16,5	17
417	HYUNDAI, KIA K7959108B001	Fits many models	Trim Panel Clips	12	14 - 26	19
419	SSANG YONG K79519058001		Side Moulding Clips	11,5	15	12,3
441	SUBARU 909130043	Subaru Impreza 2000-2007	Trim Clips for Boot & Trunk Lining	6,5	18,1	17,3
452	HYUNDAI, KIA 877583L000	Hyundai Sorento, Grandeur, Sonata. Kia.Ssangyong	Moulding Clips	14,8	17,9x16/ 20x18	21,6
456A,B	HYUNDAI, KIA 877153K000	Hyundai Azera, Equus, Genesis, Sonata, Tucson & Veloster and Kia Soul	Moulding Clips	11,7	11x9	12,8
494	HYUNDAI KIA 9215522000	Fits many models	Fender Liner Splash Shield Screw	6,2	15,8	22

363



Ø 7,5 mm,
T = 17 mm,
H = 17 mm

366



Ø 6 mm,
T = 15 - 22 mm,
H = 13 mm

390



Ø 11 mm,
T = 16,5 mm,
H = 17 mm

452



Ø 14,8 mm,
T = 17,9 x 16/20 x 18 mm,
H = 21,6 mm

369



Ø 11 mm,
T = 26 mm,
H = 16 mm

417



Ø 12 mm,
T = 14 - 26 mm,
H = 19 mm

456A



Ø 11,7 mm,
T = 11 x 9 mm
H = 12,8 mm

AVAILABLE
COLOURS

A B C

DIMENSIONS

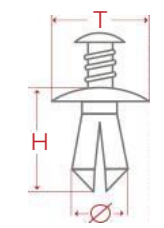

371A



Ø 5,6 mm,
T = 5,4 - 14,4 mm,
H = 14,1 mm

419



Ø 11,5 mm,
T = 15 mm,
H = 12,3 mm

456B



Ø 11,7 mm,
T = 11 x 9 mm
H = 12,8 mm



441



Ø 6,5 mm,
T = 18,1 mm,
H = 17,3 mm

494



Ø 6,2 mm,
T = 15,8 mm
H = 22 mm

AUTO BODY CLIPS



AUDI - VW SEAT - SKODA	1
BMW	17
CITROEN - PEUGEOT RENAULT	25
FIAT - LANCIA ALFA ROMEO IVECO	33
FORD - VOLVO	37
OPEL - DAEWOO SAAB GM - CHEVROLET - PONTIAN CHRYSLER - JEEP	45
MERCEDES BENZ	55
SUBARU - SUZUKI HYUNDAI - ISUZU - KIA	61
TOYOTA - MAZDA NISSAN LEXUS - MITSUBISHI HONDA - ROVER	67
UNIVERSAL	85
HOSE MENDERS	112

CODE	OEM	MODEL	USAGE	Ø (mm)	T (mm)	H (mm)
06A,B,C	HONDA, ACURA 91503SZ3003	Honda Acura 3.5 RL Sedan, (> 1996). Fits many models	Bumper & Trim Clips-Rivet Clips Fasteners Bonnet, Grille etc.	10	20	17
07A,B,C	RENAULT 0155309321, MITSUBISHI MR328954, HONDA 91545SE0003, NISSAN 0155309321	Honda, Nissan, Mitsubishi Montero, Space Runner, Galant Saloon	Bumper & Trim Clips-Rivet Clips Fasteners Bonnet, Grille etc.	8	20	12
08A,B,C	HONDA 91503SP0003, DAEWOO 94530623, BMW 07130702966	Honda Accord, Civic, CRX, Legend, Prelude, Daewo. BMW E81, E82, E83: Fits many models	Bumper & Trim Clips-Rivet Clips Fasteners Bonnet, Grille etc.	10	20	17
09A,B,C	HYUNDAI, KIA 0G03250037A	Hyundai, Kia. Fits many models	Bumper & Trim Clips-Rivet Clips Fasteners Bonnet, Grille etc.	8	18	15
11A,B,C	MITSUBISHI MB547806, NISSAN BAS01370	Nissan Micra, Primera, Mazda. Fits many models	Bumper & Trim Clips, Wheel arch cover	8	22	24
28A,B,C		Fits many models	Trim Panel Clips	6,5	16	21
31A		Nissan Cefiro, Cima, Fairlady Z, Laurel	Plastic Speed Nuts, Spire Clips for Fixing Wheel Arch Lining & Splashguard			
31B	NISSAN 63848D4000	Nissan Cefiro, Cima, Fairlady Z, Laurel	Plastic Speed Nuts, Spire Clips for Fixing Wheel Arch Lining & Splashguard			
32A,B,C		Fits many models	Trim Panel Clips	6	17,5	12
33A,B,C		Fits many models	Plastic Bumper, Fascia, Shield & Trim Clips	8	17	16
45A,B,C	HONDA 91518SM4003	Honda Accord, Prelude, Civic, CRV, HRV, NSX, Inspire, Integra	Weatherstrip Clips - For rubber door seals, door gasket clips	6 - 8	12	11
46A,B,C		Fits many models	Weatherstrip Clips - For rubber door seals, door gasket clips	6	21	10
54A,B,C	A) MITSUBISHI Mb020923, B) Mu481187	Fits many models	Hood Insulation Retainers	7 - 9	26	10
55A,B,C		Fits many models	Bumper & Sill Trim Clips	12	22	17,5

AVAILABLE COLOURS
A B C

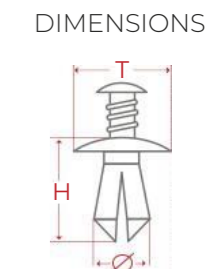

06A B C



Ø 10 mm,
T = 20 mm,
H = 17 mm

07A B C



Ø 8 mm,
T = 20 mm,
H = 12 mm

08A B C



Ø 10 mm,
T = 20 mm,
H = 17 mm

09A B C



Ø 8 mm,
T = 18 mm,
H = 15 mm

11A B C



Ø 8 mm,
T = 22 mm,
H = 24 mm

28A B C



Ø 6,5 mm,
T = 16 mm,
H = 21 mm

31A



31B



32A B C



Ø 6 mm,
T = 17,5 mm,
H = 12 mm

33A B C



Ø 8 mm,
T = 17 mm,
H = 16 mm

45A B C



Ø 6 - 8 mm,
T = 12 mm,
H = 11 mm

46A B C



Ø 6 mm,
T = 21 mm,
H = 10 mm

54A B C



Ø 7 - 9 mm,
T = 26 mm,
H = 10 mm

55A B C



Ø 12 mm,
T = 22 mm,
H = 17,5 mm

CODE	OEM	MODEL	USAGE	Ø (mm)	T (mm)	H (mm)
59	TOYOTA 9018906028, 9018906188, 9018906212		Wheel Arch Cover Retainers	8	20,5	24,7
62A,C		Toyota Yaris, Corolla, Previa, Verso, Celica, Camry, Hilux, Land Cruiser, MR2, Avensis, Rav 4, Lexus LS430, Rx300	Trim Panel Clips. Anti-Vibration Rubber Washer	8	13 - 18	20
62B,D		Toyota Yaris, Corolla, Previa, Verso, Celica, Camry, Hilux, Land Cruiser, MR2, Avensis, Rav 4, Lexus LS430, Rx300	Door Trim Panel Retainers. Anti-Vibration Rubber Washer	8,5	13 - 18	20
63A,B,C		Fits many models	Rivet Panel Clips Bumper, Engine Undertray, Sideskirts	8	20	12
69A,B,C		Fits many models	Bumper & Grille Cover Clips	10	20,6	19,4
74A,B,C		Fits many models	Rivet Panel Clips Bumper, Engine Undertray, Sideskirts	6,5	12,8	11,5
75A,B,C		Fits many models	Rivet Panel Clips Bumper, Engine Undertray, Sideskirts	6,5	17,6	11,5
79A,B,C		Fits many models	Trim Panel Clips	8	20,5	16
81A,B,C	MITSUBISHI Mr288150, SUBARU 909130013	Fits many models	Interior Door Panel Trim	6	15	13
102A,B		Fits many models	Trim Panel Clips. Anti-Vibration Rubber Washer	8	13 - 17	19
106A,B	TOYOTA, LEXUS 9046710161, MITSUBISHI Mu000504, MAZDA GE4T68865A, SUZUKI 0940910312	Toyota Yaris, Corolla, Previa, Verso, Celica, Camry, Hilux, Land Cruiser, MR2, Avensis, Rav 4 Lexus LS430, Rx300	Trim Panel Clips Trim Panel Clips. Anti-Vibration Rubber Washer	8	13 - 19	20,2
110A,B,C		Toyota, Suzuki, Mitsubishi. Fits many models	Trim Panel Clips	6,5	22	21
111A,B,C		Honda, Toyota, Mitsubishi. Fits many models	Scrivet Clips - For mudguards bumpers side skirts & trim	9	20	34
112A,B,C		Mitsubishi, Suzuki, Toyota. Fits many models	Trim Clips, Front & Rear Bumper Retainer Screw Fit	9	22,8	18

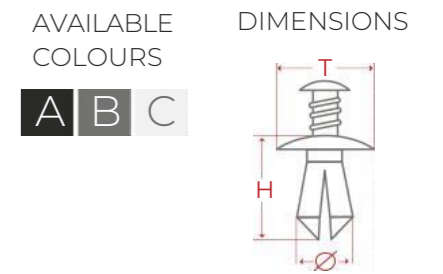

Ø 8 mm,
T = 20,5 mm,
H = 24,7 mm



Ø 8 mm,
T = 13 - 18 mm,
H = 20 mm



Ø 8,5 mm,
T = 13 - 18 mm,
H = 20 mm



Ø 8 mm,
T = 20 mm,
H = 12 mm



Ø 10 mm,
T = 20,6 mm,
H = 19,4 mm



Ø 6,5 mm,
T = 12,8 mm,
H = 11,5 mm



Ø 6,5 mm,
T = 17,6 mm,
H = 11,5 mm



Ø 8 mm,
T = 20,5 mm,
H = 16 mm



Ø 6 mm,
T = 15 mm,
H = 13 mm



Ø 8 mm,
T = 13 - 17 mm,
H = 19 mm



Ø 8 mm,
T = 13 - 18 mm,
H = 20,2 mm



Ø 6,5 mm,
T = 22 mm,
H = 21 mm



Ø 9 mm,
T = 20 mm,
H = 34 mm



Ø 9 mm,
T = 22,8 mm,
H = 18 mm

CODE	OEM	MODEL	USAGE	Ø (mm)	T (mm)	H (mm)
113A,B,C		Honda, Toyota, Mitsubishi. Fits many models	Bumper Clips	9	26	34
114A,B,C		Honda, Mazda, Mitsubishi, Nissan, Subaru, Suzuki. Fits many models	Trim Panel Clips	7	22	16
115A,B,C		Mitsubishi, Suzuki, Toyota. Fits many models	Bumper Clips	8	22,3	15
121A,B,C		Honda, Mazda, Mitsubishi, Nissan, Subaru, Suzuki. Fits many models	Trim Panel Clips	7	15	15
122	HONDA ACURA 90505SL0003, MITSUBISHI M888869, TOYOTA 9046708155	Fits many models	Bumper, Front fender	8	20,1	36,5
129A,B,C	HONDA 91560SP0003, DAEWOO 0940908301	Honda Accord, Accord Wagon, Capa, Civic, Civic Ferio, Civic Hybrid, CRV, Fit, HRV, Inspire, Integra, Logo, Odyssey, Orthia, Prelude, Saber, Step Wagon, Stream, Torneo, Acura, Mitsubishi Delica, Diamante, Galant, Legnum, Pajero, RVR, Nissan AD, Caravan, Homy, Cube, Dutsun, Elgrand, Gloria, Laurel, Primera, Pulsar, Safary, Skyline, Sunny, Tino, Vannet Serena, Wingroad, X-Trail, Toyota Caldina, Camry, Vista, Carina, Celica, Corolla, Corona, Crown, Fun Cargo, Grand Hiace, Granvia, Ipsum, Land Cruiser, Mr 2, Prius, Rav 4	Interior Door Panel and Trim Retainer. Anti-Vibration Rubber Washer	8,5	13 - 16,5	18,7
133A,B,C		Fits many models	Trim Panel Clips	7	19	15
139A,B,C		Fits many models	Bumper & Grille Cover Clips	10	20	21,7
146, B,D	AUDI, BMW, FORD, OPEL 443857847B4PK	Universal	Belt Buckle Buttons- Holders Studs Retain- er Stopper Rest Pin			
193A,B,C	TOYOTA 9046709093	Toyota Avalon, Camry, Celica, Corolla, Echo, MR2, Paseo, Sequoia, Sienna, Supra, T100, Tacoma, Tercel, Tundra. Lexus LS400, LX400, Sc430	Bumper Clips	9	15	34
194A,B,C		Fits many models	Trim Panel Clips	7	20	15
196	HONDA, TOYOTA 6786712150	Honda Civic (2002-2005), CRV (2002-2006), Fit (2007>), Jazz (2007>) Toyota Yaris	Door - panel Radiator - grille	6,6	5 - 15	15
211A,B,C		Honda, Mazda, Mitsubishi, Nissan, Subaru, Suzuki, Toyota	Fits many models: Bumper & Sill Trim Clips	10	20,8	27,8
212A,B	ACURA, HONDA 91560SZ3003	Fits many models	Door Trim Panel Retainers. Anti-Vibration Rubber Washer	8,5	16,5	18,5

113A B C



Ø 9 mm,
T = 26 mm,
H = 34 mm

114A B C



Ø 7 mm,
T = 22 mm,
H = 16 mm

115A B C



Ø 8 mm,
T = 22,3 mm,
H = 15 mm

121A B C



Ø 7 mm,
T = 15 mm,
H = 15 mm

122



Ø 8 mm,
T = 20,1 mm,
H = 36,5 mm

129A



Ø 8,5 mm,
T = 13 - 16,5 mm,
H = 18,7 mm

133A B C



Ø 7 mm,
T = 19 mm,
H = 15 mm

139A B C



Ø 10 mm,
T = 20 mm,
H = 21,7 mm

146



B N
D N

193A B C



Ø 9 mm,
T = 15 mm,
H = 34 mm

194A B C



Ø 7 mm,
T = 20 mm,
H = 15 mm

196



Ø 6,6 mm,
T = 5 - 15 mm,
H = 15 mm

211A B C



Ø 10 mm,
T = 20,8 mm,
H = 27,8 mm

212A



Ø 8,5 mm,
T = 16,5 mm,
H = 18,5 mm

AVAILABLE COLOURS
A **B** **C**

DIMENSIONS

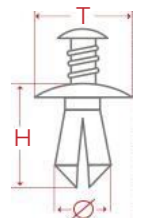

CODE	OEM	MODEL	USAGE	Ø (mm)	T (mm)	H (mm)
224A		Honda, Mazda, Mitsubishi, Nissan, Subaru, Suzuki, Toyota. Fits many models	Door Trim Panel Clips. <i>Anti-Vibration Rubber Washer</i>	8,5	18	19
228	HONDA 91530SP1003		Weatherstrip Clips - For rubber door seals, door gasket clips	5	8	11
234A,B,C		Honda, Mazda, Mitsubishi, Nissan, Subaru, Suzuki, Toyota. Fits many models	Trim Panel Clips	7	15	15
235A,B,C		Honda, Mazda, Mitsubishi, Nissan, Subaru, Suzuki, Toyota. Fits many models	Trim Panel Clips	6	19	13
237	HONDA 91502SP0003, DAEWOO 94530624	Acura, Honda, Toyota	Trim Clips - Front & Rear Bumper Retainer Screw Fit Plastic Fasteners	10	20	28
238A,B,C	HONDA 91512SX0003, MITSUBISHI Mu000319		Wheel Arch Cover Retainers, Bumper Trim	8	20	13
239	NISSAN 6682401G00, MITSUBISHI Mr462748	Mitsubishi Colt, Legnum Nissan Bassara, Cefiro, Datsun, Laurel	Bumper Clips Trim Panel Clips	6	11,4	15
240A,B	TOYOTA-LEXUS 9046710167, GM, PONTIAC 88970345	Toyota Corolla, 4Runner (2013>), CH-R (2016>), FJ Cruiser (2007-2014), Prius (2013>), Rav 4 (1999>), Yaris (2006>), Land Cruiser (2008>)	Trim Clips. <i>Anti-Vibration Rubber Washer</i>	8,5	18	20
241	LEXUS 6777112040, TOYOTA 6777130100	Toyota Camry Gracia (1996-2001), Cresta (1989-1992)	Door trim Clips	8,8	18	20,9
249			Fastening elements	10,5	24	19,8
257	NISSAN A21085	Nissan Murano	Panel Moulding Clips	10,5	18 - 21	14,5
258A,B,C	LEXUS 9046707201, TOYOTA 9046707201	Lexus ES300 / ES330 (> 2002)	Clips for Engine Bay Covers & Shields	7	20,5	15
260	MAZDA G18K51SJ3	Mazda 3, 5, 6, CX-7	Side Moulding Clips	10	18,5	18,3
262	HONDA 91513SJK003	Honda Accord, Tourer, Civic, CR-V, CR-V I-CTDI, CR-V I-DTEC, Jazz	Tailgate / Bootlid Cover Plastic Trim Clips	7,5	20	19,7

224A



Ø 8,5 mm,
T = 18 mm,
H = 19 mm

228



Ø 5 mm,
T = 8 mm,
H = 11 mm

AVAILABLE COLOURS

A B C

DIMENSIONS

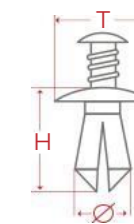

234A B C



Ø 7 mm,
T = 15 mm,
H = 15 mm

235A B C



Ø 6 mm,
T = 19 mm,
H = 13 mm

237



Ø 10 mm,
T = 20 mm,
H = 28 mm

238A B C



Ø 8 mm,
T = 20 mm,
H = 13 mm

239



Ø 6 mm,
T = 11,4 mm,
H = 15 mm

240A



Ø 8,5 mm,
T = 18 mm,
H = 20 mm

241



Ø 8,8 mm,
T = 18 mm,
H = 20,9 mm

249



Ø 10,5 mm,
T = 24 mm,
H = 19,8 mm

257



Ø 10,5 mm,
T = 18 - 21 mm,
H = 14,5 mm

258A B C



Ø 7 mm,
T = 20,5 mm,
H = 15 mm

260



Ø 10 mm,
T = 18,5 mm,
H = 18,3 mm

262



Ø 7,5 mm,
T = 20 mm,
H = 19,7 mm

CODE	OEM	MODEL	USAGE	Ø (mm)	T (mm)	H (mm)
263	HONDA 91506S9A003	Fits many models	Bumper & Trim Clips- Rivet Clips Fasteners Bonnet, Grille etc.	7,5	20	19,7
267		Fits many models	Trim Panel Clips	6,5	16	18
272	RENAULT 7703077421, 7701470769	Renault Dacia	Side Moulding Clips	8	18	15,3
273			Side Moulding Clips	7	18	15,7
282	LAND ROVER MWC9134	Freelander, Range Rover	Plastic Trim Clip /Stud Fastener for Interior Door Card	5	14	20,8
285	TOYOTA 7687944010	Toyota	Front and Rear Spoiler Locking Fasteners		15	9
301		Toyota		6	20	27,7
308		Toyota		5	15,8	18
325	TOYOTA 7549260020	Toyota, Lexus	Wheel Arch Trim & Side Moulding Clips	8	18	29,5
333	CHEVROLET 95008221, DAEWOO 94530670, GM6777113020, LEXUS, SUZUKI, TOYOTA 30006620, 0940908320	Toyota Corolla, 4Runner, Camry, Land Cruiser, Lx470 GM	Trim Panel Clips Door Trim Clips	8,5	17,8	21,7
334	HONDA 90657SB0003	Honda Accord (1983-2002), CR-V (2002-2006), Odyssey (1995-1998), Prelude (1983-2001), Legend	Engine Undertray, Splash guards & Wheel Arch Lining Clips	6,2	10,5	22
339A,B,C	FIAT 71741883, TOYOTA 9046707164, SUZUKI 0940907332	Fiat Sedici. Toyota Yaris, Auris Hybrid. Suzuki Swift	Wheel arch cover	7	20	15
345	HONDA 575306SZAA01	Fits many models	Side Moulding Clips			
349	TOYOTA 75306SZAA01	Fits many models	Side Moulding Clips	8	15	13,3

263



Ø 10 mm,
T = 20 mm,
H = 30 mm

267



Ø 6,5 mm,
T = 16 mm,
H = 18 mm

AVAILABLE
COLOURS

A B C

DIMENSIONS

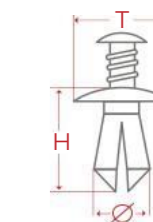

272



Ø 8 mm,
T = 18 mm,
H = 15,3 mm

273



Ø 7 mm,
T = 18 mm,
H = 15,7 mm

282



Ø 5 mm,
T = 14 mm,
H = 20,8 mm

285



T = 15 mm,
H = 9 mm

301



Ø 6 mm,
T = 20 mm,
H = 27,7 mm

308



Ø 5 mm,
T = 15,8 mm,
H = 18 mm

325



Ø 8 mm,
T = 18 mm,
H = 29,5 mm

333



Ø 8,5 mm,
T = 17,8 mm,
H = 21,7 mm

334



Ø 6,2 mm,
T = 10,5 mm,
H = 22 mm

339A B C



Ø 7 mm,
T = 20 mm,
H = 15 mm

345



Ø 10 mm,
T = 7,5 - 10 mm,
H = 16 mm

349



Ø 8 mm,
T = 15 mm,
H = 13,2 mm

CODE	OEM	MODEL	USAGE	Ø (mm)	T (mm)	H (mm)
350	HONDA 91560S9AA01	Honda Acura TL, TSX, Honda Accord, Civic, CRV, Odyssey (2002)	Side Moulding Clips Anti-Vibration Rubber Washer	8,5	13 - 16,5	18
356	LAND ROVER Lr003290	Land Rover LR2 Freelander (1983 - 2006)	Headliner Locator Pins - Plastic Clips Roof Lining	8 - 8	20	26,4
357		Land Rover	Trim Panel Clips	7 - 10	9 - 18	21,2
358	HONDA 90666SDAA01, MITSUBISHI Mq907568	Honda, Acura. Fits many models	Cover Bar Fairing Snap Clips	7,4 - 8		18
360	TOYOTA, LEXUS 9046707211	Toyota Avalon, Camry & Highlander (> 2005), Lexus IS & LS, Scion	Engine Cover Clips - Plastic Trim Fasteners for Motor Shields & Panels	6,8	19	19,5
361	NISSAN 0128100601	Nissan Maxima	Side Moulding Clips	8,4	16,3	16,4
362	TOYOTA 6777102030	Fits many models	Door Trim Panel Retainers	8	17,7	20,7
368	HONDA 7530550A003	Honda Civic (2001-2011), CR-V (2000-2006)	Trim Clips - For exterior door mouldings, side trim & bumpstrip	10	13,4 - 18,4	13,7
373	NISSAN 7701049008		Plastic Clips for Interior Door Cards. Trim Panels	5,5	21,5	19,3
374	TOYOTA 7539860021, 7539860020	Toyota. Fits many models	Side Moulding and Wheel Arch Trim Clips	8,3 - 7,5	12 - 31	28,7
375	TOYOTA, LEXUS 7588460010	Toyota, Lexus. Fits many models	Side Moulding and Wheel Arch Trim Clips	8	18,5	20,5
376	TOYOTA, LEXUS 7588160010	Toyota, Lexus. Fits many models	Side Moulding and Wheel Arch Trim Clips	8,5	18,2	30,3
378	HONDA 91513SM4000	Honda Accord (> 1991)	Plastic Side Sill / Skirt Upper Mounting Trim Clip Fastener	10,5	19,5 - 20	27,5
379	HONDA 75305sh2003	Honda Accord, Civic - CR-V (> 1996), CRX	Trim Clips - For exterior door mouldings, side trim & bumpstrip	11	12 - 14,6	17,1

350



Ø 8,5 mm,
T = 13 - 16,5 mm,
H = 18 mm

356



Ø 8 - 8 mm,
T = 20 mm,
H = 26,4 mm

AVAILABLE
COLOURS

A B C

DIMENSIONS

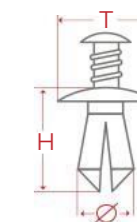

357



Ø 7 - 10 mm,
T = 9 - 18 mm,
H = 21,2 mm

358



Ø 7,4 - 8 mm,
H = 18 mm

360



Ø 6,8 mm,
T = 19 mm,
H = 19,5 mm

361



Ø 8,4 mm,
T = 16,3 mm,
H = 16,4 mm

362



Ø 8 mm,
T = 17,7 mm,
H = 20,7 mm

368



Ø 10 mm,
T = 13,4 - 18,4 mm,
H = 13,7 mm

373



Ø 5,5 mm,
T = 21,5 mm,
H = 19,3 mm

374



Ø 8,3 - 7,5 mm,
T = 12-31 mm,
H = 28,7 mm

375



Ø 8 mm,
T = 18,5 mm,
H = 20,5 mm

376



Ø 8,5 mm,
T = 18,2 mm,
H = 30,3 mm

378



Ø 10,5 mm,
T = 19,5 - 20 mm,
H = 27,5 mm

379



Ø 11 mm,
T = 12 - 14,6 mm,
H = 17,1 mm

CODE	OEM	MODEL	USAGE	Ø (mm)	T (mm)	H (mm)
380	TOYOTA, LEXUS 7539533030		Side Moulding Clips	7,5	18	18,3
382	ACURA, HONDA 90505SM4003	Honda Accord, Accord Inspire, Accord Wagon, Inspire, Odyssey, Prelude	Bumper Clips, Wheel Arch Cover Retainers	8	18	24,7
386	TOYOTA 9046710077	Avalon, Corolla (> 1998)	Side Moulding Clips	7,5	15,4	14,8
387	TOYOTA, LEXUS 9046711063	Toyota Rav4	Bumper Clips	8	18	18
388	TOYOTA, LEXUS 7588360010	Fits many models	Wheel Arch Trim & Side Moulding Clips	7,5	18	30
391	HONDA 75305SH4003	Honda Civic, Odyssey Prelude, Accord, CR-V, Acura RL, CL, TSX, RSX	Wheel Arch Trim Clips- Front Wing Trim	11	24 - 25	15,4
394	TOYOTA 7539735010	Toyota 4Runner (2003-2011), FJ Cruiser (2007-2011), Highlander (2008-2011), RAV4 (2006-2011)	Side Moulding Wheel Arch Flare Plastic Trim Clips	8,5	17	22,5
396	TOYOTA 5216120010	Fits many models	Bumper Clips	9	18	35
397	LEXUS 7539260030	Lexus (> 2000)	Side Moulding Clips	10	18	17
408		Fits many models		12	16 - 21	150
409		Toyota: Fits many models		7 - 8	18,4	160
410		Toyota, Hiace: Fits many models		12 - 15	16 - 21	170
411		Toyota: Fits many models		6 - 10,5	16 - 21	165

380



Ø 7,5 mm,
T = 18 mm,
H = 18,3 mm

382



Ø 8 mm,
T = 18 mm,
H = 24,7 mm

AVAILABLE
COLOURS

A B C

DIMENSIONS

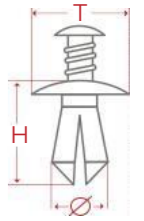

386



Ø 7,5 mm,
T = 15,4 mm,
H = 14,8 mm

387



Ø 8 mm,
T = 18 mm,
H = 18 mm

388



Ø 7,5 mm,
T = 18 mm,
H = 30 mm

391



Ø 11 mm,
T = 24 - 25 mm,
H = 15,4 mm

394



Ø 8,5 mm,
T = 17 mm,
H = 22,5 mm

396



Ø 9 mm,
T = 18 mm,
H = 35 mm

397



Ø 10 mm,
T = 18 mm,
H = 17 mm

408



Ø 12 mm,
T = 16 - 21 mm,
H = 150 mm

409



Ø 7 - 8 mm,
T = 18,4 mm,
H = 160 mm

410



Ø 12 - 15 mm,
T = 16 - 21 mm,
H = 170 mm

411



Ø 6 - 10,5 mm,
T = 16 - 21 mm,
H = 165 mm

CODE	OEM	MODEL	USAGE	Ø (mm)	T (mm)	H (mm)
412	MAZDA 992890753	Mazda: Fits many models.		6 - 7	10 - 19	110
416	TOYOTA 7549535010	Fits many models	Side Moulding & Wheel Arch Flare Plastic Trim Clips	8	17	16,5
418	LAND ROVER DYC500020		Windscreen Side Moulding Retaining Clip	7,5	17,3	18,7
421	LAND ROVER DKP5279L, FORD W701194 S300 6696122	Rover: (1989-2004). Ford: Transit (1994-2000)	Rear Door Trim Panel - Door Card Stud	5,7	12,4	22,3
422	TOYOTA 4774950090, 5387950020	TOYOTA Corolla Verso, Camry. LEXUS IS, Lexus GS, Lexus Ls460, Lexus LFA, Lexus Rx300	Front Bumper Retainer			
438	TOYOTA 538790R010, 5387928010	Toyota Highlander, TACOMA, XD Fits many models RAV4 (2006-2018)	Front Bumper Retainer			
441	TOYOTA 9046710183	Toyota Auris (2006-2012), Avenis (2003-2008), Avenis (1997-2003), Camry (2002-2006), Camry (1996-2001), Celica (1999-2005) Corolla (2002-2008), Corolla (2008-2013), Corolla Verso (2004-2009), Hiace (2005-), Hiace (1995-2005).	Fender Liner Retainer	6,5	18,1	17,3
442	TOYOTA 4774958010	Auris, Corolla, Auris Hybrid, Avenis, Prius, Camry	Front Fender Bumper Cover	5,4	15	22
455	HONDA ACURA 90688S0003	Fits many models	Panel Clips	6,2	17,9	16,9
459	HONDA 90672SA00030, MAZDA 992891053			9,4	18,9x 9,7 mm	142
461	HONDA 90687SB0003	Fits many models	Panel Clips	6	13,5	17,6

412

Ø 6 - 7 mm,
T = 10 - 19 mm,
H = 110 mm

416

Ø 8 mm,
T = 17 mm,
H = 16,5 mm

AVAILABLE COLOURS

A B C

DIMENSIONS

418

Ø 7,5 mm,
T = 17,3 mm,
H = 18,7 mm

421

Ø 5,7 mm,
T = 12,4 mm,
H = 22,3 mm

422 (N)

438 (N)

441

Ø 6,5 mm,
T = 18,1 mm,
H = 17,3 mm

442

455

Ø 6,2 mm,
T = 17,9 mm,
H = 16,9 mm

459

461

Ø 6 mm,
T = 13,5 mm,
H = 17,6 mm



UNIVERSAL

Ø 3-5 mm

12A **B**



Ø 3 - 5 mm, T = 10 mm,
H = 16 mm

13A **B**



Ø 3 - 5 mm, T = 14 mm,
H = 16 mm

14A **B**



Ø 3 - 5 mm, T = 22 mm,
H = 16 mm

37



Weatherstrip Clips - For rubber
door seals, door gasket clips

Ø 3 - 5 mm, T = 5 - 14,5 mm,
H = 16 mm

AVAILABLE
COLOURS
A **B** **C**

DIMENSIONS

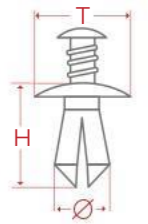

Ø 5,5 - 6,5 mm

177A **B**



Ø 5,5 - 6,5 mm,
T = 14 mm,
H = 21 mm

178A **B**



Ø 5,5 - 6,5 mm,
T = 18 mm,
H = 21 mm

179A **B**



Ø 5,5 - 6,5 mm,
T = 24 mm,
H = 21 mm

180A **B**



Ø 5,5 - 6,5 mm,
T = 28 mm,
H = 22 mm

181A **B**



Ø 5,5 - 6,5 mm,
T = 32 mm,
H = 23 mm

Ø 6 - 7 mm

21A



Ø 6 - 7 mm,
T = 14 mm,
H = 21 mm

21B



Ø 6 - 7 mm,
T = 18 mm,
H = 21 mm

21C



Ø 6 - 7 mm,
T = 24 mm,
H = 21 mm

21D



Ø 6 - 7 mm,
T = 28 mm,
H = 21 mm

21E



Ø 6-7 mm,
T = 32 mm,
H = 21 mm

UNIVERSAL

AVAILABLE COLOURS

A B C

DIMENSIONS

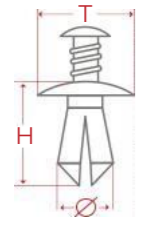

Ø 6 - 7 mm

Ø 7 mm

UNIVERSAL

AVAILABLE COLOURS

A B C

DIMENSIONS

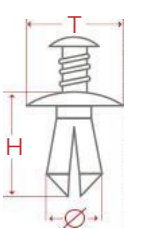

23A



Ø 6 - 7 mm,
T = 14 mm,
H = 21 mm

23B



Ø 6 - 7 mm,
T = 18 mm,
H = 21 mm

172A_B



Dimensions:
Ø 7 mm,
T = 14 mm,
H = 22 mm

173A_B



Dimensions:
Ø 7 mm,
T = 18 mm,
H = 22 mm

23C



Ø 6 - 7 mm,
T = 24 mm,
H = 21 mm

23D



Ø 6 - 7 mm,
T = 28 mm,
H = 21 mm

23E



Ø 6 - 7 mm,
T = 32 mm,
H = 21 mm

174A_B



Ø 7 mm,
T = 24 mm,
H = 22 mm

175A_B



Ø 7 mm,
T = 28 mm,
H = 22 mm

176A_B



Ø 7 mm,
T = 32 mm,
H = 22 mm

45A_B



Fits many models -
Weatherstrip Clips - For
rubber door seals, door
gasket clips

Ø 6,8 mm, T = 12 mm, H = 11 mm

46A_B



Fits many models -
Weatherstrip Clips - For
rubber door seals, door
gasket clips

Ø 6,8 mm, T = 21 mm, H = 10 mm

169_C



Ø 6 - 7 mm,
T = 14 mm,
H = 21 mm

186A_B



Ø 7 mm,
T = 25 mm,
H = 23 mm

243



Protection cover
Ø 7,7 mm,
T = 22 mm,
H = 6,5 mm

Ø 7 - 8 mm

171_C



Ø 6 - 7 mm,
T = 18 mm,
H = 21 mm

264



Hood Prop Rod
Retainer
Ø 6,5 - 9 mm,
T = 15 - 18,5 mm,
H = 20,5 mm

265



Hood Prop Rod
Retainer
Ø 6,5 - 9 mm,
H = 18,1 mm

16A_B_C



Ø 7 - 8 mm,
T = 22 mm,
H = 20 mm

18A_B_C



Ø 7 - 8 mm,
T = 19 mm,
H = 20 mm

67A_B



Ø 7 - 9 mm,
T = 22 mm,
H = 20 mm

Ø 8 mm

266



Hood Prop Rod
Retainer
Ø 6,5 mm,
T = 9 - 10 mm,
H = 19 mm

268



Hood Prop Rod
Retainer
Ø 7 mm,
T = 15,7 mm,
H = 23 mm

270



Hood Prop Rod
Retainer
Ø 6 mm,
H = 24,2 mm

58B



Screw Grommets
Expanding Nuts
Ø 8 mm,
T = 13 - 13 mm,
H = 9 mm

77A



Ø 8 mm,
T = 18 mm,
H = 24,5 mm

77B



Ø 8 mm,
T = 24 mm,
H = 24,5 mm

393



Protection cover
Ø 6 mm,
T = 24 mm,
H = 9 mm

77C



Ø 8 mm,
T = 28 mm,
H = 24,5 mm

77D



Ø 8 mm,
T = 32 mm,
H = 24,5 mm

77E



Ø 8 mm,
T = 36 mm,
H = 24,5 mm

UNIVERSAL

AVAILABLE COLOURS

A B C

DIMENSIONS

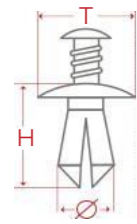

78A



Ø 8 mm,
T = 18 mm,
H = 24,5 mm

78B



Ø 8 mm,
T = 24 mm,
H = 24,5 mm

78C



Ø 8 mm,
T = 28 mm,
H = 24,5 mm

78D



Ø 8 mm,
T = 32 mm,
H = 24,5 mm

78E



Ø 8 mm,
T = 36 mm,
H = 24,5 mm

182C



Ø 8 mm,
T = 18 mm,
H = 24,5 mm

183C



Ø 8 mm,
T = 24 mm,
H = 24,5 mm

15D



Ø 9 - 10 mm,
T = 32 mm,
H = 23 mm

15E



Ø 9 - 10 mm,
T = 36 mm,
H = 23 mm

17A



Ø 9 - 10 mm,
T = 18 mm,
H = 23 mm

17B



Ø 9 - 10 mm,
T = 24 mm,
H = 23 mm

17C



Ø 9 - 10 mm,
T = 28 mm,
H = 23 mm

17D



Ø 9 - 10 mm,
T = 32 mm,
H = 23 mm

17E



Ø 9 - 10 mm,
T = 36 mm,
H = 23 mm

19A B C



Ø 9 - 10 mm,
T = 22 mm,
H = 20 mm

UNIVERSAL

AVAILABLE COLOURS

A B C

DIMENSIONS

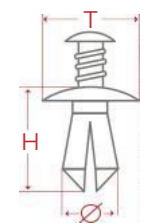

Ø 8,2 - 8,5 mm

58C



Screw Grommets
Expanding Nuts

Ø 8,5 mm, T = 13 - 13 mm,
H = 9,5 mm

58D



Wheel Arch Lining
Screw Grommet

Ø 8,2 mm, T = 17 - 17 mm,
H = 9,5 mm

76A



Mounting Trims &
Screw Grommet for
Panels into Metal
Bodywork

Ø 8,2 mm,
T = 13,2 - 13,2 mm,
H = 9,5 mm

76B



Screw Grommets
Expanding Nuts

Ø 8,5 mm, T = 11-11 mm,
H = 9,5 mm

58A



Screw Grommet for Mounting Trims &
Panels into Metal Bodywork

Ø 10 mm, T = 15,3 - 15,3 mm, H = 11,8 mm

Ø 9,5 mm

245



Protection cover

Ø 9,5 mm, T = 19 mm, H = 6 mm

Ø 12,5 mm

244



Protection cover

Ø 12,5 mm, T = 22 mm, H = 6 mm

Ø 9 - 10 mm

15A



Ø 9 - 10 mm,
T = 18 mm,
H = 23 mm

15B



Ø 9 - 10 mm,
T = 24 mm,
H = 23 mm

15C



Ø 9 - 10 mm,
T = 28 mm,
H = 23 mm

Ø 19 mm

242



Protection cover

Ø 19 mm, T = 29,2 mm, H = 9 mm

246



Protection cover

Ø 19 mm, T = 25 mm,
H = 6,5 mm

AVAILABLE COLOURS

A B C

DIMENSIONS

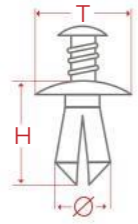

247



Protection cover

Dimensions:
Ø 21,8 mm, T= 28,5 mm, H = 6 mm

96



Gas cover

98

Trailer lock cap



A



B



C



D



E

161



Sun visor clip.
Fits many models

146



B (N)



D (N)

OEM: 443857847B

Seat Belt Stopper
Belt Holder
Stopper Buckle Stop Button Fastener
clip

METAL FASTENINGS ELEMENTS

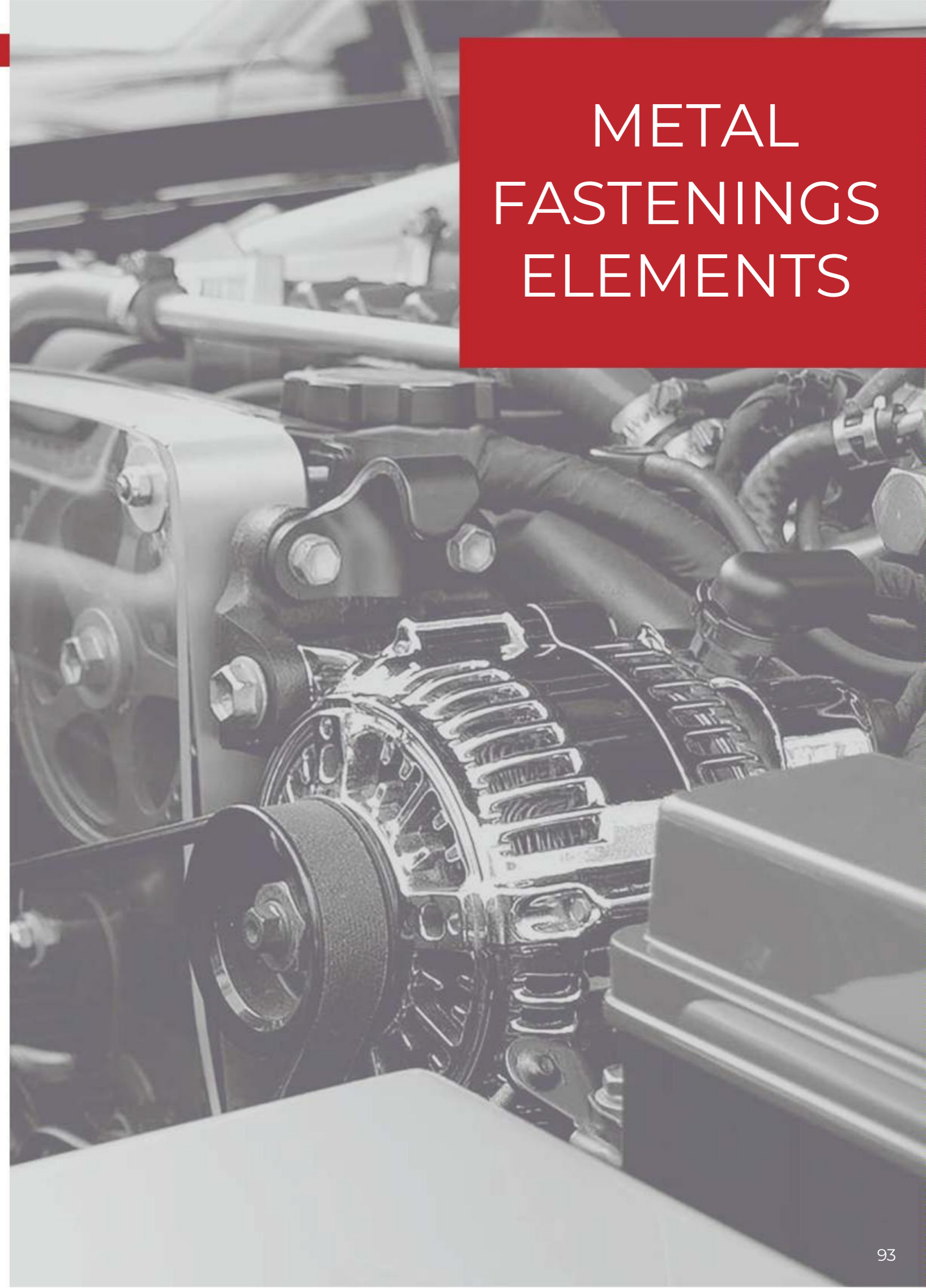

CODE	OEM	MODEL	USAGE	Ø (mm)	T (mm)	H (mm)
144A 144B	AUDI, VW 8D0805121 8D0805121B	Audi, 100 C4, A4, B5, B6, B7, A6, C4, C5, C6, A8. VW Passat B5	Engine Undertray Cover Fixing Clips. Suitable for this holder: 144C	A) 4,2 B) 4,2	18,3 18,3	21,5 22,5
144C	8D0805960	Audi, 100 C4, A4, B5, B6, B7, A6, C4, C5, C6, A8. VW Passat B5	Engine Protection Pan Speed Nut. Suitable for this holder: 144A, 144B	4,5	25 - 25	9
198		VW, Audi. Fits many models		5	14,2	21,1
283	AUDI N90335004, VW N90335004	Fits many models	Metal clamp washer clips engine cover	5	30,4	3
284	AUDI N90796502	VW Golf IV / V, Lupo, New Beetle, Polo (> 2002) Scirocco (> 2009), Touran, Transporter: Audi A3, A4, A5, A6, Q5, Q7: Fits many models	Metal clamp washer clips engine cover	4,5	30	3
285	7687944010	Toyota Corolla, Prius Solara Matrix	Front Bumper - Spoiler Clip		15	9
286		Fits many models		3,3	13,5 - 20,5	4
287		Fits many models		5	16,3 - 20,3	6,1
288	BMW 1437194187	3 Series (1990-2007), 5 Series (1988- 2012), 7 Series (1986-1994), 8 Series (1989-1998), X Series (1998-2012), Z Series (1997-2009)	Metal Bracket Clamps Clamp	4		
289	SAAB 92152112, RENAULT 7703080096, OPEL 856563	Opel: Astra F, Calibra, Corsa B, Movano A, Movano B, Omega A, Omega B, Tigra A, Vectra A, Vectra, Renault: Master I, Master II. Saab: 9-3 (2002-2012), 9-5 (1995-2010), 900 (1994-1998)	Exhaust Mount Clip	16	16,3 - 20,3	9
290		Fits many models		4	13 - 20	4,3
291		Fits many models		3	11 - 16,6	4
292		Fits many models		5,4	14,5 - 25	4,5
293	GM 11503714	Chrysler, Ford, GM. Fits many models		6		
294	PEUGEOT 694383, RENAULT 7703046034	Fits many models		6		
295	FORD 608980 MERCEDES-BENZ A0039941545	Fits many models		8		
296		BMW: 3, 5, 7, Alpina, M3, M5, M6, X3, X5	Engine Undertray Cover Fixing Clips	4,2	18,3	22,3
297				6	17	24,7
298				6	15,4	19,2
299				5	18	21,8

144A



Ø 4,2 mm ,
T= 18,3 mm,
H = 21,5 mm

144B



Ø 4,2 mm ,
T= 18,3 mm,
H = 22,5 mm

144C



Ø 4,5 mm,
T = 25 - 25 mm,
H = 9 mm

AVAILABLE
COLOURS



DIMENSIONS

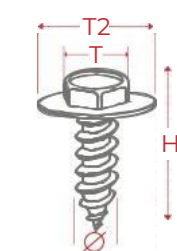

198



Ø 5 mm,
T = 14,2 mm,
H = 21,1 mm

283



Ø 5 mm, T = 30,4 mm,
H = 3 mm

284



Ø 4,5 mm, T = 30 mm,
H = 3 mm

285



T = 15 mm,
H = 9 mm

286



Ø 3,3 mm,
T= 13,5 - 20,5 mm,
H = 4 mm

287



Ø 5 mm,
T= 16,3 - 20,3 mm,
H = 6,1 mm

288



Ø 4mm

289



T = 16,3 - 20,3 mm,
H = 9 mm

290



Ø 4 mm,
T= 13 - 20 mm,
H = 4,3 mm

291



Ø 3 mm,
T= 11 - 16,6 mm,
H = 4 mm

292



Ø 5,4 mm,
T = 14,5 - 25 mm,
H = 4,5 mm

293



Ø 6 mm

294



Ø 6 mm

295



Ø 8 mm

296



Ø 4,2 mm ,
T= 18,3 mm,
H = 22,3 mm

297



Ø 6 mm,
T = 17 mm,
H = 24,7 mm

298



Ø 6 mm,
T = 15,4 mm,
H = 19,2 mm

299



Ø 5 mm,
T = 18 mm,
H = 21,8 mm

CODE	OEM	MODEL	USAGE	Ø (mm)	T (mm)	H (mm)
300				5,1	15	24,5
301				6	20	27,7
302				6	24	28,5
303				5	16,2	22
304				6	16	20,5
305				5	15	21,7
306				8	16,5	22,2
307				4,5	16	23,3
308		Toyota		5	15,8	18
309				6	20	25
310				6	15,6	20
311				6	17	39
312				5,2	18	26,3
313				6	17	30
314				5	14,5	22
315	GM 11501188			8	24	35,5
316				5	12,3	24
317				5	18	18,6

AVAILABLE COLOURS
A B C

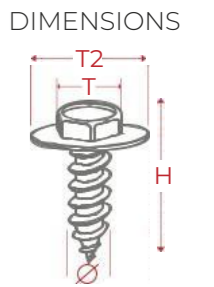

300



Ø 5,1 mm,
T = 15 mm,
H = 24,5 mm

301



Ø 6 mm,
T = 20 mm,
H = 27,7 mm

302



Ø 6 mm,
T = 24 mm,
H = 28,5 mm

303



Ø 5 mm,
T = 16,2 mm,
H = 22 mm

304



Ø 6 mm,
T = 16 mm,
H = 20,5 mm

305



Ø 5 mm,
T = 15 mm,
H = 21,7 mm

306



Ø 8 mm,
T = 16,5 mm,
H = 22,2 mm

307



Ø 4,5 mm,
T = 16 mm,
H = 23,3 mm

308



Ø 5 mm,
T = 15,8 mm,
H = 18 mm

309



Ø 6 mm,
T = 20 mm,
H = 25 mm

310



Ø 6 mm,
T = 15,6 mm,
H = 20 mm

311



Ø 6 mm,
T = 17 mm,
H = 39 mm

312



Ø 5,2 mm,
T = 18 mm,
H = 26,3 mm

313



Ø 6 mm,
T = 17 mm,
H = 30 mm

314



Ø 5 mm,
T = 14,5 mm,
H = 22 mm

315



Ø 8 mm,
T = 24 mm,
H = 35,5 mm

316



Ø 5 mm,
T = 12,3 mm,
H = 24 mm

317



Ø 5 mm,
T = 18 mm,
H = 18,6 mm

CODE	OEM	MODEL	USAGE	Ø (mm)	T (mm)	H (mm)
318				6	17	27,8
320	AUDI, SEAT, SKODA, VW 4A0867276	Audi A4 B6, A5, Q7 (2005-2009). VW Bora, Golf IV, V, Polo (2001-2005), Passat B6, Tiguan. Seat Ibiza (2002-2008), Leon (1999-2005), (2005-2013), Toledo (1999-2005). Skoda Octavia II, Fabia, Roomster, Superb	Boot door trim clips	6,5	9 - 18	22
321	AUDI, VW 3B9867289, SEAT 4A0867276B	Audi A4 B6, A5, Q7 (2005-2009). VW Bora, Golf IV, V, Polo (2001-2005), Passat B6, Tiguan. Seat Ibiza (2002-2008), Leon (1999-2005), (2005-2013), Toledo (1999-2005). Skoda Octavia II, Fabia, Roomster, Superb	Boot door trim clips	8	9 - 16	15,7
322				5	15 - 21,3	16,5
323	ALFA ROMEO, FIAT, LANCIA		Screw for Bumper	6	17 - 18	24,7
324		Audi, Seat, Skoda, VW, Peugeot	Screw for Bumper	6	19,3	23,5
327B		Audi, mercedes benz				
328				4,9	14,3	19
329		Universal		5	15,2 - 21,1	14,5
330		Universal		3,3	14,6 - 26,3	4,3
423				3,9	11,1 - 25	4,8
424	VW, AUDI 4D0611715B	Audi, Volkswagen, Skoda. Fits many models	Brake Line Retaining Spring	16,1	17,2 - 28	4,5
426				8	17 - 33	14,3
427				4	22	2,5

318



Ø 6 mm,
T = 17 mm,
H = 27,8 mm

320



Ø 6,5 mm,
T = 9 - 18 mm,
H = 22 mm

AVAILABLE COLOURS



DIMENSIONS

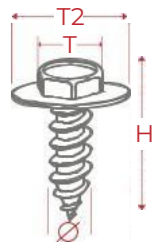

321



Ø 8 mm,
T = 9 - 16 mm,
H = 15,7 mm

322



Ø 5 mm,
T = 15 - 21,3 mm,
H = 16,5 mm

323



Ø 6 mm,
T = 17 - 8 mm,
H = 24,7 mm

324



Ø 6 mm,
T = 19,3 mm,
H = 23,5 mm

327B



328



Ø 4,9 mm,
T = 14,3 mm,
H = 19 mm

329



Ø 5 mm,
T = 15,2 - 21,1 mm,
H = 14,5 mm

330



Ø 3,3 mm,
T = 14,6 - 26,3 mm,
H = 4,3 mm

423



Ø 3,9 mm,
T = 11,1 - 25 mm,
H = 4,8 mm

424



Ø 16,1 mm,
T = 17,2 - 28 mm,
H = 4,5 mm

426



Ø 8 mm,
T = 17 - 33 mm,
H = 14,3 mm

427



Ø 4 mm,
T = 22 mm,
H = 2,5 mm

CODE	OEM	MODEL	USAGE	Ø (mm)	T (mm) T2 (mm)	H (mm)
428				6	15 - 30	9,5
429				3	13,5 - 27	5,2
480		Mercedes		4,7	7,9x7,9 25,7	24,5
481		VW		4,9	11,8 20	24,5
483	RENAULT 7703017090	Megane 2 Laguna 2	Screw Wheel Arch	4,7	9,1 15,2	28
484			Self Washer Coach Screw	6	10 17,5	30,5
485	HYUNDAI 92155-22000			6,2	15,2	22
486				5,4	7,7x7,7 15	22
487				6,2	9,7x9,7 17,8	24,6
488				3,9	21,6 x 16,2	5,1
489				5,9	9x9 16,8	24,2
491		Toyota 7539242030	Bumper-Side Retainer	5,2	7,8x7,8 11,9	23,4
492		Toyota 9015960525	Bumper cover screw	6,4	9,8x9,8 20	23,9
494		Hyundai Kia 9215522000	Fender Liner Splash Shield Screw	6,2	15,8	22
497	AUDI ,BMW, VOLKSWAGEN					

428



Ø 6 mm,
T = 15 - 30 mm,
H = 9,5 mm

429



Ø 3 mm,
T = 13,5 - 27 mm,
H = 5,2 mm

AVAILABLE
COLOURS

A B C

DIMENSIONS



480



Ø 4,7 mm,
T = 7,9 x 7,9 mm,
T2 = 25,7 mm
H = 24,5 mm

481



Ø 4,9 mm,
T = 11,8 mm,
T2 = 20 mm
H = 24,5 mm

483



Ø 4,7 mm,
T = 9,1 mm,
T2 = 15,2 mm
H = 28 mm

484



Ø 6 mm,
T = 10 mm,
T2 = 17,5 mm
H = 30,5 mm

485



Ø 6,2 mm,
T = 15,2 mm,
H = 22 mm

486



Ø 5,4 mm,
T = 7,7 x 7,7 mm,
T2 = 15 mm
H = 22 mm

487



Ø 6,2 mm,
T = 9,7 x 9,7 mm,
T2 = 17,8 mm
H = 24,6 mm

488



Ø 3,9 mm,
T = 21,6 x 16,2 mm,
H = 5,1 mm

489



Ø 5,9 mm,
T = 9 x 9 mm,
T2 = 16,8 mm
H = 24,2 mm

491



Ø 5,2 mm,
T = 7,8 x 7,8
T2 = 11,9 mm,
H = 23,4 mm

492



Ø 6,4 mm,
T = 9,8 x 9,8
T2 = 20 mm,
H = 23,9 mm

494



Ø 6,2 mm,
T = 15,8 mm,
H = 22 mm

497



RIVETS



RIVETS

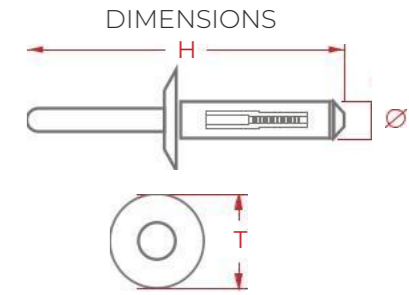

398



OEM: FORD
N804759S

Fits many models:
Blind Rivet Front
Bumper Cover Clip

Ø 6,1 mm, T = 16,9 mm,
H = 57,6 mm

399



OEM: CHRYSLER
4370138, 6503860,
FORD N804675S

Fits many models:
Blind Rivet Front
Bumper Cover Clip

Ø 6,4mm, T = 16,9 mm,
H = 54 mm

400



OEM: GM 10109689,
12337915

Fits many models:
Blind Rivet Front
Bumper Cover Clip

Ø 6,4 mm, T = 18 mm,
H = 54 mm

401



OEM: GM
10184895,
20452072, FORD
N803862-S,
CHRYSLER
6501559

Fits many models:
Blind Rivet Front
Bumper Cover Clip

Ø 6 mm, T = 13 mm,
H = 55 mm

402



OEM: GM
20612732

Fits many models:
Blind Rivet Front
Bumper Cover Clip

Ø 4,8 mm, T = 9 mm,
H = 49 mm

403



OEM: GM
20423647, FORD
N804189S

Fits many models:
Blind Rivet Front
Bumper Cover Clip

Ø 5 mm, T = 6,5 mm,
H = 47,4 mm

404



OEM: CHRYSLER
6500898

Fits many models:
Blind Rivet Front
Bumper Cover Clip.

Ø 4,9 mm, T = 7,3 mm,
H = 51,6 mm

405



OEM: CHRYSLER,
JEEP, DODGE
34201631

Fits many
models:
Blind Rivet Front
Bumper Cover Clip

Ø 6 mm, T = 17 mm,
H = 55 mm

406



OEM: GM
20421672, 15955172

Fits many models:
Blind Rivet Front
Bumper Cover Clip

Ø 6,5 mm, T = 13 mm,
H = 47 mm

425



Fits many models:
Blind Rivet Front
Bumper Cover Clip

Ø 5 mm, T = 13,8 mm,
H = 21 mm



FIR TREE
MOUNT
CABLE TIES



215

Ø 7 x 7 mm,
T = 11,9 mm,
H = 119,4 mm

9 mm

(N)

DIMENSIONS

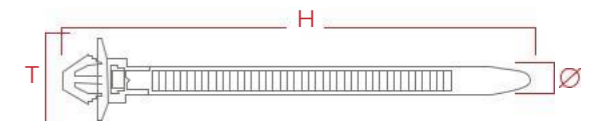

407

**OEM: MERCEDES BENZ
1149970290**

Ø 7,5 mm,
T = 12 mm,
H = 160 mm



410

Toyota Hiace

Ø 12 - 15 mm,
T = 16 - 21 mm,
H = 170 mm



408

**OEM: MAZDA
992890753**

Ø 12 mm,
T = 16 - 21 mm,
H = 150 mm



411

Toyota

Ø 6 - 10,5 mm,
T = 16 - 21 mm,
H = 165 mm



409

Toyota

Ø 7 - 8 mm,
T = 18,4 mm,
H = 160 mm



412

OEM: MAZDA 992890753

Ø 6 - 7 mm,
T = 10 - 19 mm,
H = 110 mm

DIMENSIONS

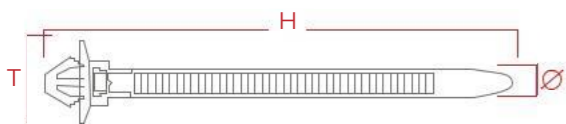

413



Universal
 Ø 7,9 mm,
 T = 11,6 mm,
 H = 205 mm

(N)

414



Universal
 Ø 6 mm,
 T = 16 mm,
 H = 200 mm

430



Ø 4 mm,
 H = 200 mm

431



Universal
 Ø 3 mm,
 H = 200 mm

432



Universal
 Ø 6,5 mm,
 T = 16 mm,
 H = 200 mm

437



Universal
 T = 16 mm,
 H = 20,5 mm

4,5 mm

Universal
 T = 16 mm,
 H = 20,5 mm

459



Ø 9,4 mm,
 T = 18,9 x 9,7 mm
 H = 142 mm

HOSE JOINERS

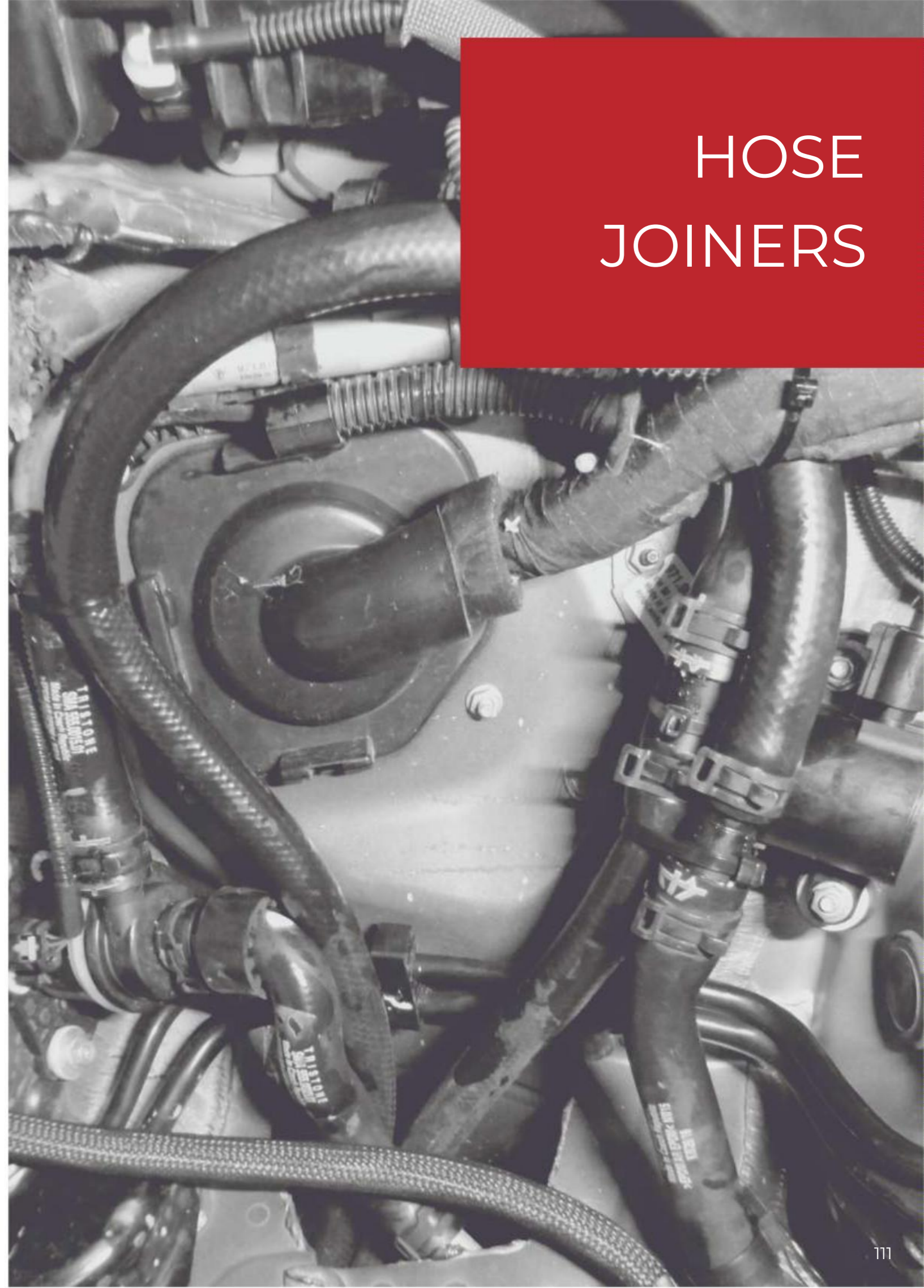

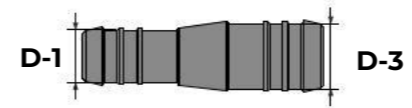

Search by the **PART DIMENSIONS**

Item code	∅	∅	Page	Item code	∅ mm	∅ mm	Page
85E	3	3	121	716C	16	8	122
85D	4	4	121	209F	16	10	122
87C	5	4	121	716B	16	12	122
85C	5	5	121	209E	16	14	122
87B	6	4	121	82C	16	16	122
87A	6	5	121	716A	18	10	122
85B	6	6	121	206D	18	16	122
105E	8	4	121	82B	18	18	122
105D	8	6	121	209C	20	14	123
85A	8	8	121	206C	20	16	123
724A	9	9	121	206B	20	18	123
105C	10	6	121	82A	20	20	123
715C	10	6	121	209B	22	16	123
715B	10	8	121	206A	22	18	123
83C	10	10	121	205E	22	20	123
715A	12	6	121	205D	22	22	123
105B	12	8	121	209A	25	18	123
714D	12	10	121	205C	25	20	123
83B	12	12	121	205B	25	22	123
714C	14	6	122	205A	25	25	123
714B	14	8	122	717C	32	25	124
105A	14	10	122	717B	32	28	124
714A	14	12	122	717A	32	32	124
83A	14	14	122				
209D	14	18	122				



High quality hose joiners made from glass fibre reinforced Polyamide 6. Safe for prolonged use between -40° and +140°C. The connectors are resistant to a range of chemicals including hydrocarbon and mineral oils, fuel and cooling system fluids as well as weak acids and alkalis.

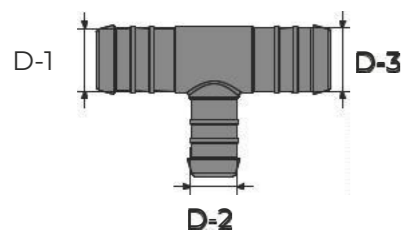

Search by the PART DIMENSIONS

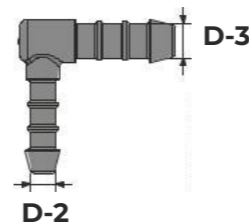

Search by the PART DIMENSIONS

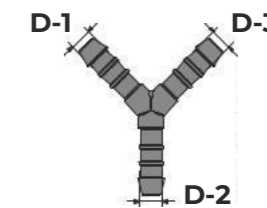

Item code	∅	∅	∅	Page
86E	3	3	3	124
86C	4	4	4	124
86D	4	6	4	124
718C	4	8	4	124
86B	5	5	5	124
86F	6	4	6	124
86A	6	6	6	125
705C	6	8	6	125
705B	6	10	6	125
704D	6	12	6	125
718B	8	4	8	125
200D	8	6	8	125
84D	8	8	8	125
705A	8	10	8	125
704C	8	12	8	125
701D	8	16	8	125
718A	10	4	10	126
704B	10	6	10	126
200C	10	8	10	126
84C	10	10	10	126
704A	10	12	10	126
703B	10	14	10	126
701C	10	16	10	126
703D	12	6	12	126
703C	12	8	12	126
200B	12	10	12	127
84B	12	12	12	127
703A	12	14	12	127
701B	12	16	12	127

Item code	∅	∅	∅	Page
702C		6	14	127
702B		8	14	127
702A		10	14	127
200A		12	14	127
84A		14	14	128
701A		16	14	128
208E		8	16	128
700C		10	16	128
700B		12	16	128
700A		14	16	128
89E		16	16	128
208D		8	18	129
208C		10	18	129
208B		14	18	129
89D		15	18	129
89C		18	18	129
208A		8	20	129
207D		12	20	129
89B		15	20	130
89A		20	20	130
207B		25	20	130
207C		16	22	130
203E		18	22	130
203D		20	22	130
203C		22	22	131
207A		20	25	131
203B		22	25	131
203A		25	25	131
722A		32	32	131

Item code	D2 ∅ mm	D3 ∅ mm	Page
104C	4	4	132
104B	5	5	132
104A	6	6	132
202D	8	4	132
202C	8	6	132
103D	8	8	132
723A ^(140°)	8	8	132
202B	10	6	132
202A	10	8	132
103C	10	10	133
706D	12	6	133
201D	12	8	133
201C	12	10	133
103B	12	12	133
706C	14	6	133
706B	14	8	133
201B	14	10	133
201A	14	12	134
103A	14	14	134
707D	16	8	134
707C	16	10	134
707B	16	12	134
707A	16	14	134
706A	16	16	134
721D	16	22	134
204E	18	16	135
204C	18	18	135
721C	18	22	135
720D	18	25	135
204D	20	16	135
204B	20	18	135
204A	20	20	136
721B	20	22	136
720C	20	25	136
721A	22	22	136
720B	22	25	136
720A	25	25	136
719C	32	25	137
719B	32	28	137
719A	32	32	137

Item code	D1 ∅ mm	D2 ∅ mm	D3 ∅ mm	Page
88E	3	3	3	137
88C	4	4	4	138
88D	4	6	4	138
88B	5	5	5	138
88A	6	6	6	138
709C	6	8	6	138
709B	6	10	6	138
709A	6	12	6	138
708D	8	8	8	139
710C	8	10	8	139
710B	8	12	8	139
710A	8	14	8	139
708C	10	10	10	139
711C	10	12	10	139
711B	10	14	10	140
708B	12	12	12	140
711A	12	14	12	140
708A	14	14	14	140
725A	16	16	16	140

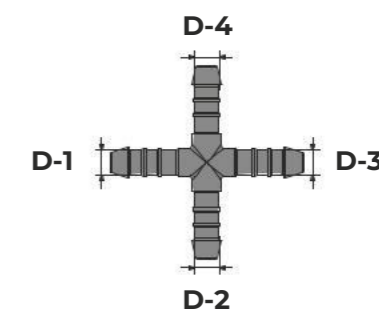

Item code	∅	∅	∅	D4 ∅ mm	Page
712D	4	4	4	4	140
712C	5	5	5	5	141
712B	6	6	6	6	141
712A	8	8	8	8	141
713D	10	10	10	10	141
713C	12	12	12	12	141
713B	14	14	14	14	141
713A	16	16	16	16	141



High quality hose joiners made from glass fibre reinforced Polyamide 6. Safe for prolonged use between -40° and +140°C. The connectors are resistant to a range of chemicals including hydrocarbon and mineral oils, fuel and cooling system fluids as well as weak acids and alkalis.





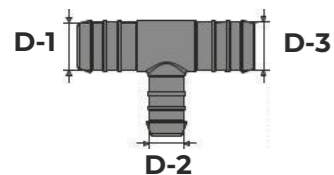



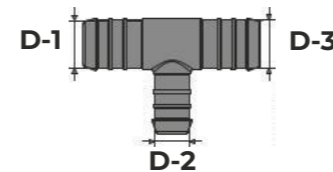









High quality hose joiners made from glass fibre reinforced Polyamide 6. Safe for prolonged use between -40° and +140°C. The connectors are resistant to a range of chemicals including hydrocarbon and mineral oils, fuel and cooling system fluids as well as weak acids and alkalis.



Search by the PART CODE



Search by the PART CODE

Item code	D1 ø mm	D2 ø mm	D3 ø mm	Page	Item code	D1 ø mm	D2 ø mm	D3 ø mm	Page	Item code	D1 ø mm	D2 ø mm	D3 ø mm	Page	Item code	D1 ø mm	D2 ø mm	D3 ø mm	Page
 82A	20		20	123	 89A	20	20	20	130	 203A	25	25	25	131	 209A	25		18	123
82B	18		18	122	89B	20	15	20	130	203B	25	22	25	131	209B	22		16	123
82C	16		16	122	89C	18	18	18	129	203C	22	22	22	131	209C	20		14	123
83A	14		14	122	89D	18	15	18	129	203D	22	20	22	130	209D	18		14	122
83B	12		12	121	89E	16	16	16	128	203E	22	18	22	130	209E	16		14	122
83C	10		10	121											209F	16		10	122
 84A	14	14	14	128	 103A		14	14	134	 204A		20	20	136					
84B	12	12	12	127	103B		12	12	133	204B		20	18	135	700A	16	14	16	128
84C	10	10	10	126	103C		10	10	133	204C		18	18	135	700B	16	12	16	128
84D	8	8	8	125	103D		8	8	132	204D		20	16	135	700C	16	10	16	128
					104A		6	6	132	204E		18	16	135	701A	14	16	14	128
 85A	8		8	121	104B		5	5	132					701B	12	16	12	127	
85B	6		6	121	104C		4	4	132	 205A	25		25	123	701C	10	16	10	126
85C	5		5	121						205B	25		22	123	701D	8	16	8	125
85D	4		4	121	 105A	14		10	122	205C	25		20	123	702A	14	10	14	127
85E	3		3	121	105B	12		8	121	205D	22		22	123	702B	14	8	14	127
					105C	10		6	121	205E	22		20	123	702C	14	6	14	127
 86A	6	6	6	125	105D	8		6	121	206A	22		18	123	703A	12	14	12	127
86B	5	5	5	124	105E	8		4	121	206B	20		18	123	703B	10	14	10	126
86C	4	4	4	124						206C	20		16	123	703C	12	8	12	126
86D	4	6	4	124	 200A	14	12	14	127	206D	18		16	122	703D	12	6	12	126
86E	3	3	3	124	200B	12	10	12	127					704A	10	12	10	126	
86F	6	4	6	124	200C	10	8	10	126	 207A	25	20	25	131	704B	10	6	10	126
					200D	8	6	8	125	207B	20	25	20	130	704C	8	12	8	125
 87A	6		5	121						207C	22	16	22	130	704D	6	12	6	125
87B	6		4	121	 201A		14	12	134	207D	20	12	20	129	705A	8	10	8	125
87C	5		4	121	201B		14	10	133	208A	20	8	20	129	705B	6	10	6	125
					201C		12	10	133	208B	18	14	18	129	705C	6	8	6	125
 88A	6	6	6	138	201D		12	8	133	208C	18	10	18	129					
88B	5	5	5	138	202A		10	8	132	208D	18	8	18	129					
88C	4	4	4	138	202B		10	6	132	208E	16	8	16	128					
88D	4	6	4	138	202C		8	6	132										
88E	3	3	3	137	202D		8	4	132										



High quality hose joiners made from glass fibre reinforced Polyamide 6. Safe for prolonged use between -40° and +140°C. The connectors are resistant to a range of chemicals including hydrocarbon and mineral oils, fuel and cooling system fluids as well as weak acids and alkalis.



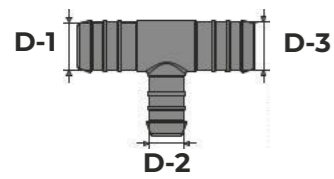

High quality hose joiners made from glass fibre reinforced Polyamide 6. Safe for prolonged use between -40° and +140°C. The connectors are resistant to a range of chemicals including hydrocarbon and mineral oils, fuel and cooling system fluids as well as weak acids and alkalis.



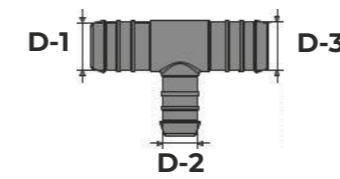

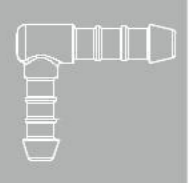

Search by the PART CODE

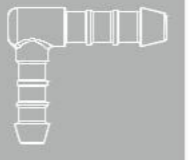

Search by the PART CODE

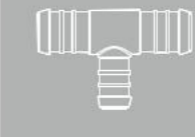
Item code	D1 ø mm	D2 ø mm	D3 ø mm	D4 ø mm	Page
 706A		16	16		134
706B		14	8		133
706C		14	6		133
706D		12	6		133
707A		16	14		134
707B		16	12		134
707C		16	10		134
707D		16	8		134
 708A	14	14	14		140
708B	12	12	12		140
708C	10	10	10		139
708D	8	8	8		139
709A	6	12	6		138
709B	6	10	6		138
709C	6	8	6		138
710A	8	14	8		139
710B	8	12	8		139
710C	8	10	8		139
711A	12	14	12		140
711B	10	14	10		140
711C	10	12	10		139
 712A	8	8	8		141
712B	6	6	6		141
712C	5	5	5		141
712D	4	4	4		140
713A	16	16	16		141
713B	14	14	14		141
713C	12	12	12		141
713D	10	10	10		141

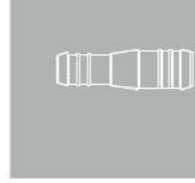
Item code	D1 ø mm	D2 ø mm	D3 ø mm	Page
 714A	14		12	122
714B	14		8	122
714C	14		6	122
714D	12		10	121
715A	12		6	121
715B	10		8	121
715C	10		6	121
716A	18		10	122
716B	16		12	122
716C	16		8	122
717A	32		32	124
717B	32		28	124
717C	32		25	124
 718A	10	4	10	126
718B	8	4	8	125
718C	4	8	4	124
 719A		32	32	137
719B		32	28	137
719C		32	25	137
720A		25	25	136
720B		25	22	136
720C		25	20	136
720D		25	18	135
721A		22	22	136
721B		22	20	136
721C		22	18	135
721D		22	16	134

Item code	D1 ø mm	D2 ø mm	D3 ø mm	Page
 722A	32	32	32	131
 723A (140°)	8	8		132
 724A	9		9	121
 725A	16	16	16	140



High quality hose joiners made from glass fibre reinforced Polyamide 6. Safe for prolonged use between -40° and +140°C. The connectors are resistant to a range of chemicals including hydrocarbon and mineral oils, fuel and cooling system fluids as well as weak acids and alkalis.



High quality hose joiners made from glass fibre reinforced Polyamide 6. Safe for prolonged use between -40° and +140°C. The connectors are resistant to a range of chemicals including hydrocarbon and mineral oils, fuel and cooling system fluids as well as weak acids and alkalis.

Hose joiners „I“ pieces

85 E



85 D



87 C



85 C



87B



87A



85B



105E



105D



85A



724A



HOSE JOINERS

105C



715C



715B



83C



715A



105B



714D



83B



Hose joiners are resistant to fuel, oil and glycol. This makes it so that the connectors are suited for use in vehicle heating and cooling systems. They are suited for continuous use between -40C and +140C

714C



714B



105A



714A



83A



209D



Ø 14 mm

716C



209F



716B



209E



82C



Ø 16 mm

716A



206D



82B



209C



206C



206B

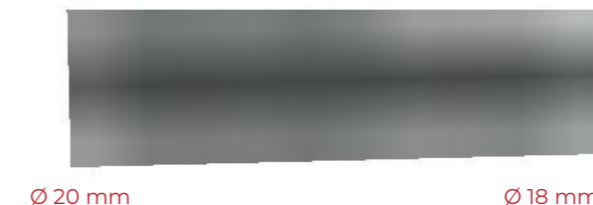

82A



Ø 20 mm

209B



206A



205E



205D



Ø 22 mm

209A



205C



205B



205A



Ø 25 mm



Hose joiners are resistant to fuel, oil and glycol. This makes it so that the connectors are suited for use in vehicle heating and cooling systems. They are suited for continuous use between -40C and +140C



Hose joiners are resistant to fuel, oil and glycol. This makes it so that the connectors are suited for use in vehicle heating and cooling systems. They are suited for continuous use between -40C and +140C

717C



Ø 32 mm Ø 25 mm

717B



Ø 32 mm Ø 28 mm

717A



Ø 32 mm Ø 32 mm

Ø 32 mm

Hose joiners „T“ pieces

86E



Ø 3 mm Ø 3 mm
Ø 3 mm

86C

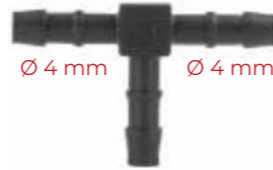

Ø 4 mm Ø 4 mm
Ø 4 mm

86D



Ø 4 mm Ø 4 mm
Ø 6 mm

718C



Ø 4 mm Ø 4 mm
Ø 8 mm

Ø 4 mm

86B



Ø 5 mm Ø 5 mm
Ø 5 mm

Ø 5 mm

86F



Ø 6 mm Ø 6 mm
Ø 4 mm

86A



Ø 6 mm Ø 6 mm
Ø 6 mm

705C



Ø 6 mm Ø 6 mm
Ø 8 mm

705B



Ø 6 mm Ø 6 mm
Ø 10 mm

704D



Ø 6 mm Ø 6 mm
Ø 12 mm

Ø 6 mm

718B



Ø 8 mm Ø 8 mm
Ø 4 mm

200D



Ø 8 mm Ø 8 mm
Ø 6 mm

84D



Ø 8 mm Ø 8 mm
Ø 8 mm

705A



Ø 8 mm Ø 8 mm
Ø 10 mm

704C



Ø 8 mm Ø 8 mm
Ø 12 mm

701D



Ø 8 mm Ø 8 mm
Ø 16 mm Ø 8 mm



Hose joiners are resistant to fuel, oil and glycol. This makes it so that the connectors are suited for use in vehicle heating and cooling systems. They are suited for continuous use between -40C and +140C



Hose joiners are resistant to fuel, oil and glycol. This makes it so that the connectors are suited for use in vehicle heating and cooling systems. They are suited for continuous use between -40C and +140C

718A



Ø 10 mm Ø 10 mm
Ø 4 mm

704B



Ø 10 mm Ø 10 mm
Ø 6 mm

200C



Ø 10 mm Ø 10 mm
Ø 8 mm

84C



Ø 10 mm Ø 10 mm
Ø 10 mm

704A



Ø 10 mm Ø 10 mm
Ø 12 mm

703B



Ø 10 mm Ø 10 mm
Ø 14 mm

701C



Ø 10 mm Ø 10 mm
Ø 16 mm

Ø 10 mm

703D



Ø 12 mm Ø 12 mm
Ø 6 mm

703C



Ø 12 mm Ø 12 mm
Ø 8 mm

Ø 12 mm

200B



Ø 12 mm Ø 12 mm
Ø 10 mm

84B



Ø 12 mm Ø 12 mm
Ø 12 mm

703A



Ø 12 mm Ø 12 mm
Ø 14 mm

701B



Ø 12 mm Ø 12 mm
Ø 16 mm

Ø 12 mm

702C



Ø 14 mm Ø 14 mm
Ø 6 mm

702B



Ø 14 mm Ø 14 mm
Ø 8 mm

702A



Ø 14 mm Ø 14 mm
Ø 10 mm

200A



Ø 14 mm Ø 14 mm
Ø 12 mm

Ø 14 mm



Hose joiners are resistant to fuel, oil and glycol. This makes it so that the connectors are suited for use in vehicle heating and cooling systems. They are suited for continuous use between -40C and +140C



Hose joiners are resistant to fuel, oil and glycol. This makes it so that the connectors are suited for use in vehicle heating and cooling systems. They are suited for continuous use between -40C and +140C

84A



Ø 14 mm Ø 14 mm

Ø 14 mm

701A



Ø 14 mm Ø 14 mm

Ø 16 mm

Ø 14 mm

208E



Ø 16 mm Ø 16 mm

Ø 8 mm

700C



Ø 16 mm Ø 16 mm

Ø 10 mm

700B



Ø 16 mm Ø 16 mm

Ø 12 mm

700A



Ø 16 mm Ø 16 mm

Ø 14 mm

89E



Ø 16 mm Ø 16 mm

Ø 16 mm

Ø 16 mm

208D



Ø 18 mm Ø 18 mm

Ø 8 mm

208C



Ø 18 mm Ø 18 mm

Ø 10 mm

208B



Ø 18 mm Ø 18 mm

Ø 14 mm

89D



Ø 18 mm Ø 18 mm

Ø 15 mm

89C



Ø 18 mm Ø 18 mm

Ø 18 mm

Ø 18 mm

208A



Ø 20 mm Ø 20 mm

Ø 8 mm

207D



Ø 20 mm Ø 20 mm

Ø 12 mm

Ø 20 mm



Hose joiners are resistant to fuel, oil and glycol. This makes it so that the connectors are suited for use in vehicle heating and cooling systems. They are suited for continuous use between -40C and +140C



Hose joiners are resistant to fuel, oil and glycol. This makes it so that the connectors are suited for use in vehicle heating and cooling systems. They are suited for continuous use between -40C and +140C

89B



Ø 20 mm Ø 20 mm

Ø 15 mm

89A



Ø 20 mm Ø 20 mm

Ø 20 mm

207B



Ø 20 mm Ø 20 mm

Ø 25 mm

Ø 20 mm

207C



Ø 22 mm Ø 22 mm

Ø 16 mm

203E



Ø 22 mm Ø 22 mm

Ø 18 mm

203D



Ø 22 mm Ø 22 mm

Ø 20 mm

Ø 22 mm

203C



Ø 22 mm Ø 22 mm

Ø 22 mm

Ø 22 mm

207A



Ø 25 mm Ø 25 mm

Ø 20 mm

203B



Ø 25 mm Ø 25 mm

Ø 22 mm

203A



Ø 25 mm Ø 25 mm

Ø 25 mm

Ø 25 mm

722A



Ø 32 mm

Ø 32 mm

Ø 32 mm

Ø 32 mm



Hose joiners are resistant to fuel, oil and glycol. This makes it so that the connectors are suited for use in vehicle heating and cooling systems. They are suited for continuous use between -40C and +140C



Hose joiners are resistant to fuel, oil and glycol. This makes it so that the connectors are suited for use in vehicle heating and cooling systems. They are suited for continuous use between -40C and +140C

Hose joiners „L“ pieces

104C



Ø 4 mm

Ø 4 mm

Ø 4 mm

104B



Ø 5 mm

Ø 5 mm

Ø 5 mm

104A



Ø 6 mm

Ø 6 mm

Ø 6 mm

202D



Ø 4 mm

Ø 8 mm

202C



Ø 6 mm

Ø 8 mm

103D



Ø 8 mm

Ø 8 mm

723A
(140°)



Ø 8 mm

Ø 8 mm

Ø 8 mm

202B



Ø 6 mm

Ø 10 mm

202A



Ø 8 mm

Ø 10 mm Ø 10 mm

103C



Ø 10 mm

Ø 10 mm

Ø 10 mm

706D



Ø 6 mm

Ø 12 mm

201D



Ø 8 mm

Ø 12 mm

201C



Ø 10 mm

Ø 12 mm

103B



Ø 12 mm

Ø 12 mm

Ø 12 mm

706C



Ø 6 mm

Ø 14 mm

706B



Ø 8 mm

Ø 14 mm

201B



Ø 10 mm

Ø 14 mm

Ø 14 mm



Hose joiners are resistant to fuel, oil and glycol. This makes it so that the connectors are suited for use in vehicle heating and cooling systems. They are suited for continuous use between -40C and +140C



Hose joiners are resistant to fuel, oil and glycol. This makes it so that the connectors are suited for use in vehicle heating and cooling systems. They are suited for continuous use between -40C and +140C



Ø 14 mm



Ø 16 mm

Ø 20 mm



Hose joiners are resistant to fuel, oil and glycol. This makes it so that the connectors are suited for use in vehicle heating and cooling systems. They are suited for continuous use between -40C and +140C



Hose joiners are resistant to fuel, oil and glycol. This makes it so that the connectors are suited for use in vehicle heating and cooling systems. They are suited for continuous use between -40C and +140C

204A



Ø 20 mm

Ø 20 mm

721A



Ø 22 mm

Ø 22 mm

719C



Ø 25 mm

Ø 32 mm

Ø 25 mm

719A



Ø 32 mm

Ø 32 mm

Ø 32 mm

721B



Ø 22 mm

Ø 20 mm

720B



Ø 25 mm

Ø 22 mm

Ø 22 mm

719B



Ø 28 mm

Ø 32 mm

Ø 28 mm

Hose joiners „Y“ pieces

88E



Ø 3 mm

Ø 3 mm

Ø 3 mm

Ø 3 mm

720C



Ø 25 mm

Ø 20 mm

Ø 20 mm

720A



Ø 25 mm

Ø 25 mm

Ø 25 mm



Hose joiners are resistant to fuel, oil and glycol. This makes it so that the connectors are suited for use in vehicle heating and cooling systems. They are suited for continuous use between -40C and +140C



Hose joiners are resistant to fuel, oil and glycol. This makes it so that the connectors are suited for use in vehicle heating and cooling systems. They are suited for continuous use between -40C and +140C

88C



709C



708D



710A



88D



Ø 4 mm

709B



710C



708C



88B



Ø 5 mm

709A



710B



711C



88A

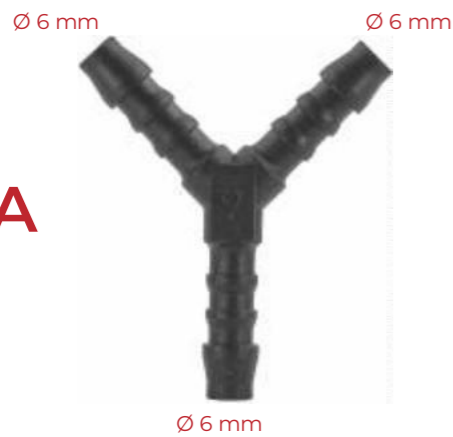

Ø 6 mm

Ø 10 mm



Hose joiners are resistant to fuel, oil and glycol. This makes it so that the connectors are suited for use in vehicle heating and cooling systems. They are suited for continuous use between -40C and +140C



Hose joiners are resistant to fuel, oil and glycol. This makes it so that the connectors are suited for use in vehicle heating and cooling systems. They are suited for continuous use between -40C and +140C



711B

Ø 10 mm



708B



711A

Ø 12 mm



708A

Ø 14 mm



725A

Ø 16 mm

Hose joiners „X“ pieces

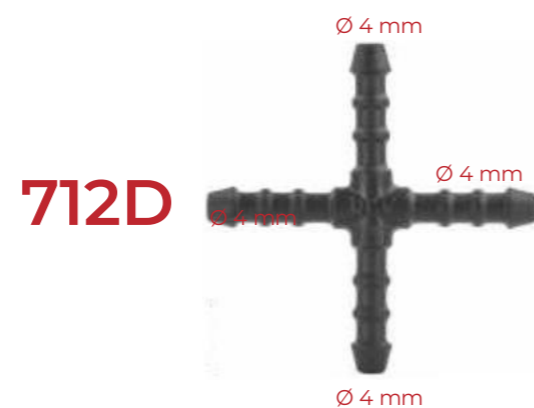

712D

Ø 4 mm

712C



Ø 5 mm

712B



Ø 6 mm

712A



Ø 8 mm

713D



Ø 10 mm

713C



Ø 6 mm

713B



Ø 6 mm

713A



Ø 16 mm



Hose joiners are resistant to fuel, oil and glycol. This makes it so that the connectors are suited for use in vehicle heating and cooling systems. They are suited for continuous use between -40C and +140C



Hose joiners are resistant to fuel, oil and glycol. This makes it so that the connectors are suited for use in vehicle heating and cooling systems. They are suited for continuous use between -40C and +140C

CV BOOTS

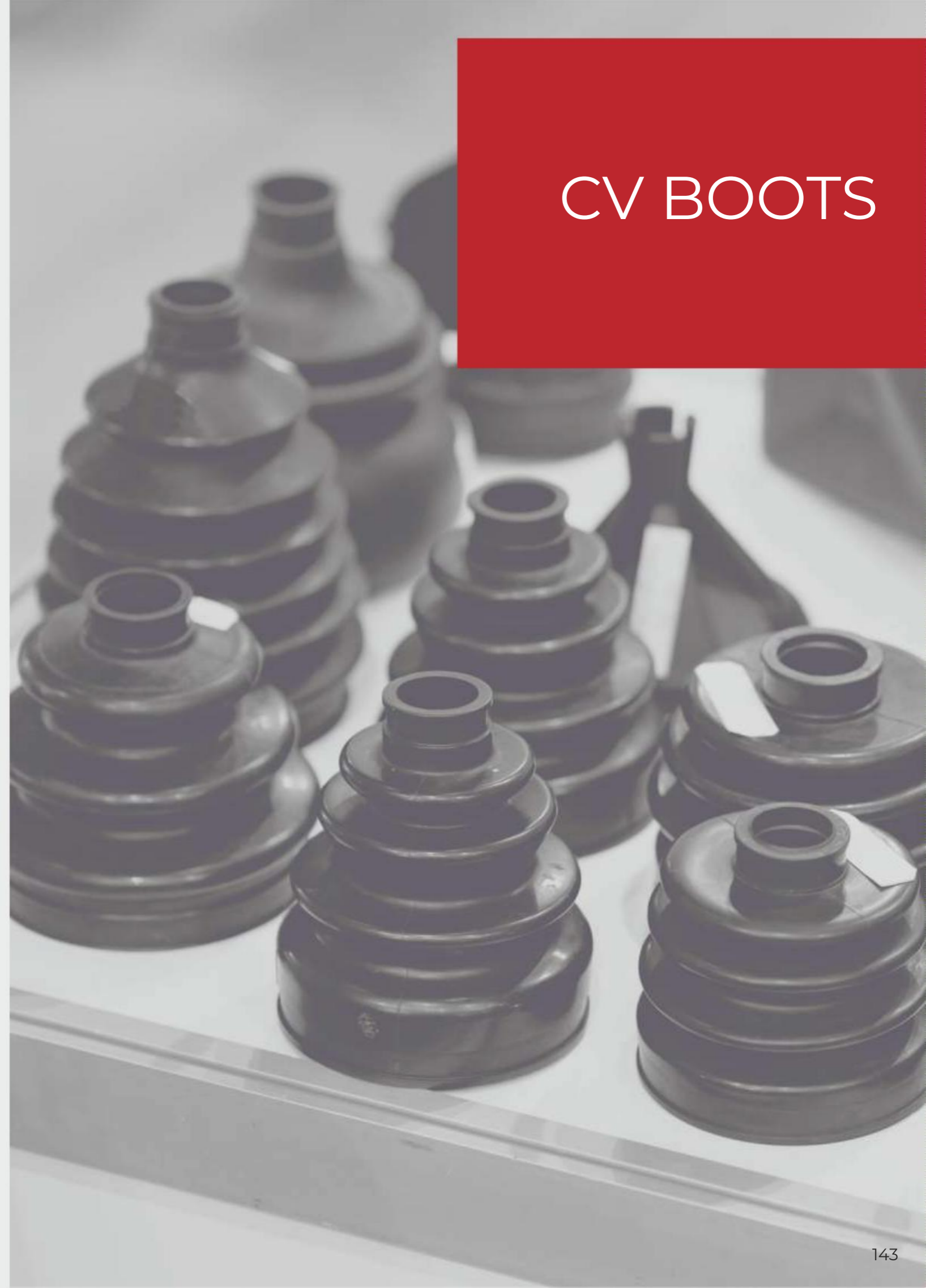

VOLKSWAGEN, ROVER



VOLKSWAGEN, FORD



BMW, VOLKSWAGEN



CV BOOTS

BMW



BMW, FIAT, RENAULT



AUDI

001



AUDI, VOLKSWAGEN

39



OEM: 8E0698470B

VW, Audi, Seat, Ford: Brake Caliper Guide Sleeve

56



Audi A4, S4 (B5- 8D) (94 - 99)
1997: Protection rubber of Door opening / closing sensor

184



OEM: AUDI, VW SKODA, SET 8E0698470

Fits many models: Brake calipers rubber

AUDI, VOLKSWAGEN, PASSAT

009



012



0145



AUDI, VOLKSWAGEN, BMW, OPEL, ROVER

000



AUDI, VOLKSWAGEN, BMW, MERCEDES BENZ

0448



STEERING RACK BUSHERS

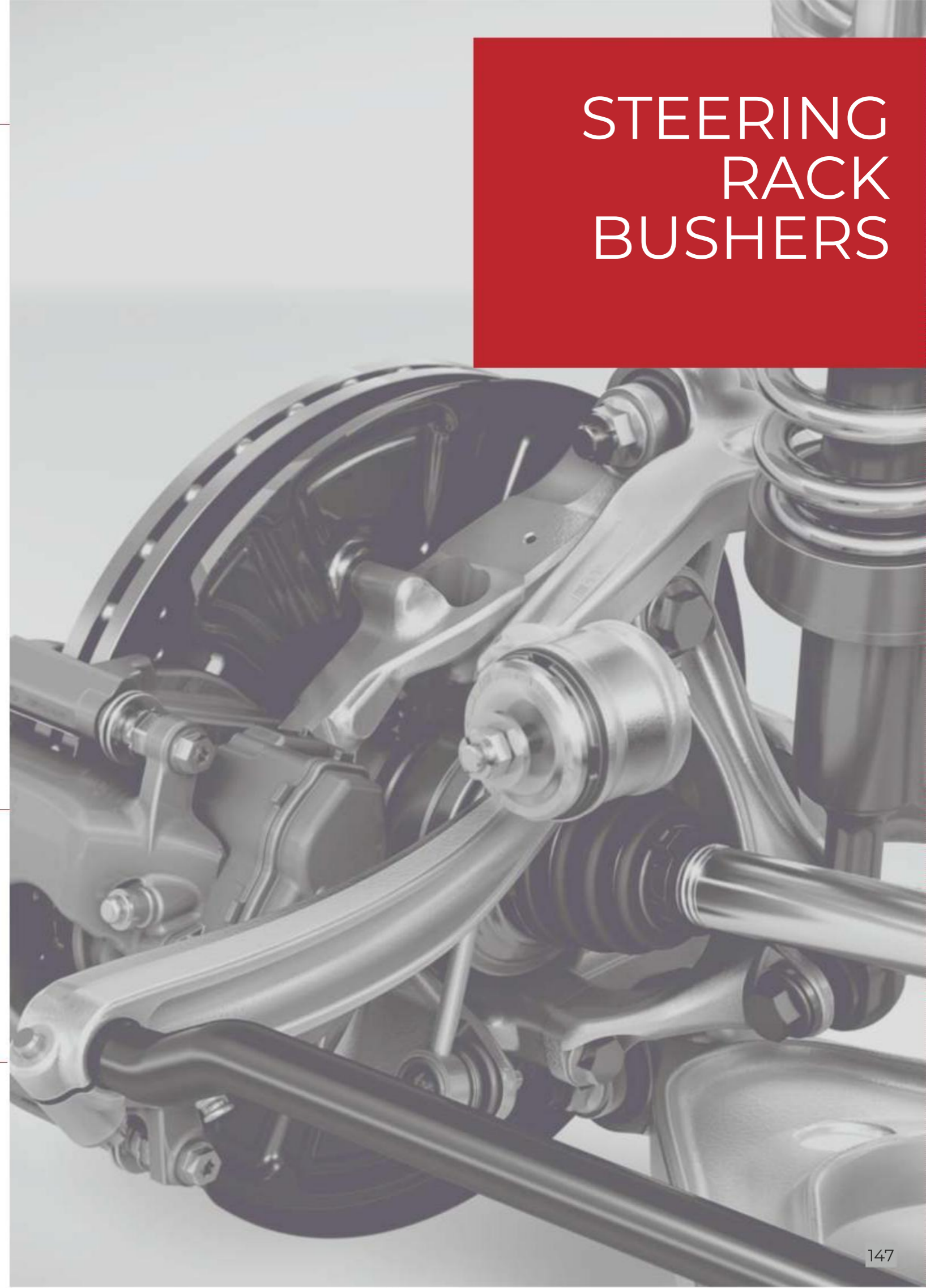

STEERING RACK BUSHERS

Search by the **OEM CODE**



019A

Ø 19 mm



020A

Ø 20 mm



021A

Ø 21 mm



022A

Ø 22 mm



024A

Ø 24 mm



026A

Ø 26 mm



027A

Ø 27 mm



030A

Ø 30 mm



541A

Audi,
VW Pasat
Ø 22 mm



019B

Ø 19 mm



020B

Ø 20 mm



021B

Ø 21 mm



022B

Ø 22 mm



024B

Ø 24 mm



026B

Ø 26 mm



027B

Ø 27 mm



030B

Ø 30 mm



541B

Audi,
VW Pasat
Ø 22 mm

Item code	Model	OEM	Page	Item code	Model	OEM	Page
337	Ford	W704958S300	41	359	GM	11518988	49
128A	Ford	100792	39	449	GM	11561368	51
142	Opel	157979	47	433	GMC	11569920	51
370	Opel	174854	51	436	GM	11571175	51
458	GM	363137	51	446	GM	11589291	51
29A	Lancia,Fiat,Alfa Romeo	598806	35	451	GM	11589293	51
295	Ford	608980	41	400	GM	12337915	53
294	Peugeot	694383	31	447	GM	14074081	51
73	Peugeot	699786	29	353	GM	15221959	49
49	Peugeot	856534	27	406	GM	15955172	53
100A	Peugeot,Citroen	856535	29	342	Mercedes Benz	19884481	59
47A,B	Peugeot,Citroen	856535	27	343	Mercedes Benz	19886081	59
41A,B	Peugeot	856540	27	215	Mercedes Benz	19974290	59
210A,B	Peugeot,Citroen	856548	32	406	GM	20421672	53
226	Citroen,Peugeot	856548	31	406	GM	20421672	53
65A	Peugeot	856553	27	403	GM	20423647	53
232	Kia	878000	63	403	GM	20423647	53
61A,B	Ford	1008068	39	401	GM	20452072	53
24A,B	Ford	1008086	47	401	GM	20452072	53
34C	Ford	1018434	39	402	GM	20612732	53
277	Ford	1038008	41	402	GM	20612732	53
20A	Ford	1104880	57	377	Cadillac	25693852	51
125	Opel	1180216	47	280	VW	28103937	13
332	Ford	1257376	41	27A	Volvo	30820141	39
451	Opel	1816589	51	457	Volvo	31214496	43
20A	BMW	1916670	57	405	Chrysler,Jeep	34201631	53
21A	Opel	2226953	87	405	Chrysler	34201631	53
53	Opel	2240587	47	395	VW	37853575	15
24A,B	Opel	2345957	39	279	Audi,VW,Seat,Skoda	38103937	13
236	Opel	2345959	49	65A	Lancia,Fiat,Alfa Romeo	51834606	27
65A	Opel	3636996	27	04	Fiat	71717421	19
275	Volvo	3923712	41	226	Fiat	71728806	35
399	Chrysler	4370138	53	339	Fiat	71741883	77
399	Chrysler	4370138	43	41A,B	Fiat	71775718	35
454	Opel	4414720	51	240A,B	Gm	88970345	75
445	Opel	4811301	51	441	Gm	88970767	49
445	Ford	4855809	42	236	Opel	90457899	49
404	Chrysler	6500898	53	370	Opel	90481595	51
404	Chrysler	6500898	53	142	Opel	90579619	47
401	Chrysler	6501559	53	289	Saab	92152112	31
401	Chrysler	6501559	53	118A	Opel	93160023	29
399	Ford	6503860	43	08A	Daewoo	94530623	19
51	Alfa Romeo	7739801	35	237	Daewoo	94530624	49
218	Volvo	8679426	41	122	GM	94852368	73
157	Volvo	9132876	41	122	GM	94852368	47
101	Volvo	9484284	39	361	Nissan	128100601	79
400	GM	10109689	53	07A	Renault,Nissan	155309321	69
126	GM	10143422	47	116B	VW	165827592	5
401	GM	10184895	53	141B	Audi,VW	171201969	7
401	GM	10184895	53	27A	Audi,VW	447857909	3
385	GM	10323057	51	453	Fiat	464089536	35
127	GM	10421018	47	118A	Iveco	500326896	47
381	Chrysler	10443956	51	51	Iveco	500382985	35
315	GM	11501188	49	48B	VW	701853585	3
293	GM	11503714	49	70B,D	Audi,VW	703867299	5
450	GM	11518017	51	137A	Renault	770372126	29
415	GM	11518357	51	70A,C	Audi,VW	823867299	5

