



MECÂNICA



We Sparkle your business

Abraçadeiras Metálicas

Abraçadeira sem fim W2 DIN 3017

- Cabeça Inox AISI 430
- Parafuso Zincado



Aperto (mm)	Largura da Banda (mm)	Referência
8-12	7,5	040812
8-12	9	050812
10-16	9	0501016
12-22	9	0501222
16-27	9	0501627
20-32	9	0502032
23-35	9	0502335
25-40	9	0502540
30-45	9	0503045
32-50	9	0503250

Aperto (mm)	Largura da Banda (mm)	Referência
32-50	9	0503250
40-60	9	0504060
50-70	9	0505070
60-80	9	0506080
70-90	9	0507090
80-100*	9	05080100
90-110*	9	05090110
100-120*	9	050100120
110-130*	9	050110130
120-140*	9	050120140

- Todas as medidas também estão disponíveis em banda de 12mm mediante encomenda
- *Apenas por encomenda

- Recomendação Resistência: 5 Nm

Abraçadeira de foles W4

- Totalmente em Inox AISI 304
- Banda de 7mm

Aperto (mm)	Referência
25-40	0522540
45-120	05245120



Chave flexível para abraçadeiras



- Sextavada 6mm: **600 040**
- Sextava 7mm : **600 041**





Expositor para abraçadeiras sem fim:

050 01

TAMPÕES DE CARTER



460560		
 21	 M10 x 1,25	Renault, Ford, Volvo, Toyota, Psa

460920		
 17	 M12 x 1,50	BMW

460810	
 M12 x 1,50	Nissan, Toyota, Lexus



460480			
 21	 8	 M14 x 1,25	Peugeot, Citroën, Fiat, Toyota, Volvo, Opel...



460670		
 19	 M14 x 1,50	Audi, VW, Ford, Seat, Skoda

460360		
 45	 M14 x 1,50	Opel Citroen Fiat



460470		
 13	 M14 x 1,50	Chrysler, Daimler, Mercedes



4603410		
 19	 M14 x 1,50	Audi, VW, Ford, Opel, Seat



460850		
 13	 M14 x 1,50	Ford, Peugeot, Citroën, Volvo, Chrysler

4607410		
 13	 M14 x 1,50	Ford

460120			
 13	 8	 M16 x 1,50	Citroën, Peugeot



460970		
 8	 M16 x 1,50	Renault

460930		
 8	 M18 x 1,50	Ford, Renault

460580		
 19	 M20 x 1,50	Nissan, Subaru

4609410		
 12	 M20 x 1,50	Peugeot, Ford, Volvo

4605410		
 10	 M22 x 1,50	Alfa, Renault, Fiat, Opel, Ford, PSA

460320		
 19	 M22 x 1,50	Seat, BMW

460750		
 17	 M26 x 1,50	Audi, VW,

ANILHAS DE COBRE

Ø Interior (mm)	Ø Exterior (mm)	Espessura (mm)	Referência
10	16	1,5	400101615
12	16	1,5	400121615
12	18	1,5	400121815
14	18	1,5	400141815
14	20	1,5	400142015
16	22	1,5	40016221
18	24	1,5	400182415
10	19	2	41010192
10	20	3	41010202
14	20	2	41014202
16	22	2	41016222

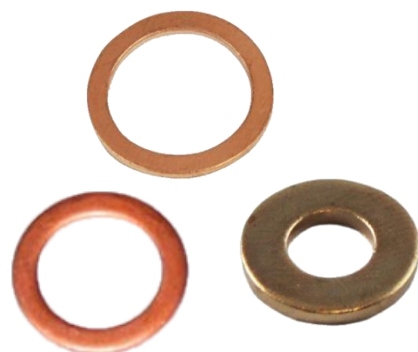

ANILHAS DE ESMAGAMENTO

Ø Interior (mm)	Ø Exterior (mm)	Espessura (mm)	Referência
10	14	1,5	420101415
12	17	2	42012172
14	20	2	42014202
14	22	2	42014222
16	22	2	42016222
18	24	2	42018242



ANILHAS DE ESMAGAMENTO

Métrica	A (mm)	B (mm)	B (mm)	T (mm)	Referência
12	9,5	12,7	18	1,5	4301218
14	11,18	14,7	22	1,5	4301422
16	13,41	16,7	24	1,5	4301624
18	14,76	18,7	26	1,5	4301826
20	16,76	20,7	28	1,5	4302028

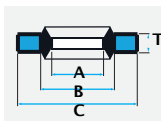

FOLES UNIVERSAIS



Kit Fole de Transmissão Universal

510 84600

Kit Fole de Transmissão Universal 4x4 /Furgons

510 84700



Kit Fole de Direção Assistida Universal

• Adaptável em combinação com os seguintes diâmetros:
Pequeno Ø 10- 23-30-40 mm

Grande Ø 28-36-41- 46-54 mm

510 84800

TUBO DE COMBUSTÍVEL

- Mangueira multiuso para uso em linhas de combustível e para conexões de mangueira de retorno de combustível em sistemas de injeção diesel. Aprovado para uso com misturas de gasolina, diesel e gasolina sem chumbo;
- Construção reforçada em espiral;
- Reforço de fibra sintética;
- A cobertura resiste ao calor, óleo e intempéries.
- Pressão de trabalho de até 1 Mpa (10kg/cm²);
- Faixa de temperatura: -40°C a +125°C.
- Atende aos requisitos do SAE J30R7 e DIN 73379;



Ø Interior	Ø Exterior	Referência
3,2	8	500 328
4	9,7	500 49
5	10,7	500 510
6	12,2	500 612
7	13,5	500 713
8	14,2	500 814
10	17,8	500 1017
12	19,3	500 1219